



Energy Strategy Report

2634, 2636, 2640, 2642 and 2654 Eglinton Avenue West and 1856 and 1856A Keele
Street

Fora Developments

Toronto, ON

November 15, 2022

Revision: 0

Issued for: Zoning By-law Amendment (ZBA) and Site Plan Application (SPA)

EXECUTIVE SUMMARY

Fora Developments has retained EQ Building Performance (EQ) to develop an Energy Strategy Report for the 2634, 2636, 2640, 2642 and 2654 Eglinton Avenue West and 1856 and 1856A Keele Street project (the “Proposed Development”). The Proposed Development is a high-rise residential development consisting of a 33 storey tower with residential suites, associated amenities, at-grade retail, and below-grade parking.

For the purposes of this report, all three Tiers of the current version of the Toronto Green Standard (version 4) have been evaluated for the new construction portion of the development, indicated as Scenario’s 1-3. A summary of predicted performance is available in Table i.

Table i - Project Performance for Each Scenario

	Scenario 1	Scenario 2	Scenario 3
Target Energy Intensity - (ekWh/m²)	135.0	100.0	75.0
Energy Intensity - (ekWh/m²)	111.6	99.3	74.3
Total Energy (eMWh)	2,968	2,641	1,977
% Savings vs Scenario 1	-	11%	33%
Target GHG Intensity (kg CO₂e/m²)	15.0	10.0	5.0
GHG Intensity (kg CO₂e/m²)	9.5	6.1	2.2
Total GHGs (tonnes CO ₂ e)	253	162	59
% Savings vs Scenario 1	-	36%	77%
Target Thermal Energy Demand Intensity (ekWh/m²)	50.0	30.0	15.0
Thermal Energy Demand Intensity (ekWh/m²)	45.8	29.9	14.6
Total Thermal Demand (eMWh)	1,218	795	388
% Savings vs Scenario 1	-	35%	68%

If the development were to pursue Tier 2, it may be eligible for up to **\$1,395,037 as a development charge refund**, using current development charge rebate rates. If Tier 3 is pursued, the project may be eligible for up to **\$1,674,046 as a development charge refund**.

Developments within Toronto are encouraged to pursue net-zero design, which is explored within this report. With changing climates and tightening requirements for existing buildings, the development may need to retrofit to achieve net zero during the life of the building. As such, strategies to explore future proofing the initial design and potential retrofit strategies are also included.

The 2634, 2636, 2640, 2642 and 2654 Eglinton Avenue West and 1856 and 1856A Keele Street development preferred scenario is to achieve Toronto Green Standard version 4 Tier 1, referred to as Scenario 1. A summary of expected building performance is outlined in the table below.

Table ii - Preferred Scenario Estimated Performance

	Estimated Performance (New Construction)
Energy Use Intensity	111.6 ekWh/m ²
Greenhouse Gas Intensity	9.5 kgCO ₂ e/m ²
Thermal Energy Demand Intensity	45.8 ekWh/m ²
Utility Cost	\$12.4 /m ²
Embodied Carbon	391 kgCO ₂ e/m ²
Cost Premium (over TGS v3 Tier 1)	TBD
Annual Carbon Offset to Achieve Net Zero	\$1,700

This report outlines design strategies to achieve each of the presented targets, as well as a preferred scenario. Advanced measures such as district energy systems and solar PV are recommended for further exploration, however, are only discussed at a preliminary level as it is early in design. Design options are also presented to provide enhanced resilience for the Proposed Development and should be evaluated further on a feasibility and cost basis.

This report is for the purposes of the rezoning and site plan approval applications submission and meets the requirements of the Energy Strategy Terms of Reference. The strategies outlined in this report should be evaluated by the design team throughout design development. Using a combination of strategies from the energy strategy report, the Proposed Development can achieve its minimum energy performance requirements.

TABLE OF CONTENTS

1.	Introduction	2
1.1	Development Summary	2
1.2	Purpose of this Report	3
1.3	How to Read This Report.....	3
1.4	Toronto Green Standard - Near Zero Emissions Development.....	4
1.5	Development Specific Energy Targets	5
2.	Energy Analysis.....	6
2.1	Project TGS Performance.....	6
2.2	Building Level Design Opportunities	8
2.3	Massing + Envelope Improvements	8
2.3.1	Passive Design Best Practices	10
2.4	Active Design Measures	21
2.4.1	Low-Carbon Energy Solutions	24
2.5	Active Design Best Practices	26
3.	Project Specific Energy Opportunities	29
3.1	Geothermal + Other Low Carbon Opportunities	29
3.2	Future Retrofit Strategies	31
4.	Renewables	33
4.1	Solar PV.....	33
4.2	Renewable Energy Certificates + Carbon Offsets	34
5.	Embodied Carbon.....	36
5.1	System Boundary	37
5.2	General Project Information.....	38
5.4	Carbon Results at Upfront Carbon Stage	39
5.5	Contribution Analysis	40
5.6	Reduction Measures Considered	41
5.7	Results Summary	43
6.	Financial Incentives	43
7.	Preferred Scenario and Recommendations	45
7.1	Operational Performance	45
7.2	Lifecycle Carbon Assessment	45

7.3 Cost Premiums..... 46

7.4 Utility Costs 46

8. Conclusions..... 49

Appendix A – Detailed Expected Energy Performance 50

Appendix B – Design Guidance 51

ACRONYMS / DEFINITIONS

Compactness Ratio – Ratio of Modelled Floor Area to exterior above-grade envelope area (window, wall, and roof). The more compact a building, the less envelope there is for heat loss.

CEDI – Cooling Energy Demand Intensity (kWh/m²) – Total cooling demand within the building (primarily reliant on building envelope and ventilation loads and internal heat gain) divided by the Modelled Floor Area (MFA)

EUI – Energy Use Intensity (kWh/m²) – Total energy use within the building divided by the Modelled Floor Area (MFA). One of three energy modeling metrics within the TGS.

GFA - The total area of all floors in a building between the outside faces of the exterior walls as reported in the architectural statistics.

GHGI – Greenhouse Gas Intensity (kgCO₂/m²) – Total carbon used within the building, calculated using carbon factors from SB-10, divided by the Modelled Floor Area (MFA). One of three energy modeling metrics within the TGS.

MFA – Modelled Floor Area – Total enclosed floor area of the building as reported in modelling software, excluding exterior areas and parking areas.

OBC SB-10 (2017) – Supplementary Standard SB-10 – Ontario Building Code energy requirements for Part 3 buildings.

SPA – Site Plan Application

TEDI – Thermal Energy Demand Intensity (kWh/m²) – Total heating demand within the building (primarily reliant on building envelope and ventilation load) divided by the Modelled Floor Area (MFA). One of three energy modeling metrics within the TGS.

TGS - Toronto Green Standard

1. INTRODUCTION

1.1 DEVELOPMENT SUMMARY

Fora Developments has retained EQ Building Performance (EQ) to develop an Energy Strategy Report for the 2634, 2636, 2640, 2642 and 2654 Eglinton Avenue West and 1856 and 1856A Keele Street project (the “Proposed Development”). The Proposed Development is a high-rise residential development consisting of a 33 storey tower with residential suites, associated amenities, at-grade retail, and below-grade parking..

The project is currently at the rezoning and site plan approval stage of development. Based on current architectural drawings and discussions with the team, this report assumes the following design attributes:

- GFA: 26,601 m²
- 370 Suites
- Window to wall ratio of approximately 60%
- Double glazed window assembly
- EIFs and Spandrel opaque wall assemblies
- Compactness ratio of 46%
- High performance geothermal plant with high efficiency heat recovery in suites
- Variable speed circulation pumps and fans
- Low flow plumbing fixtures
- The project is not yet committed to pursuing any voluntary higher performance standards.

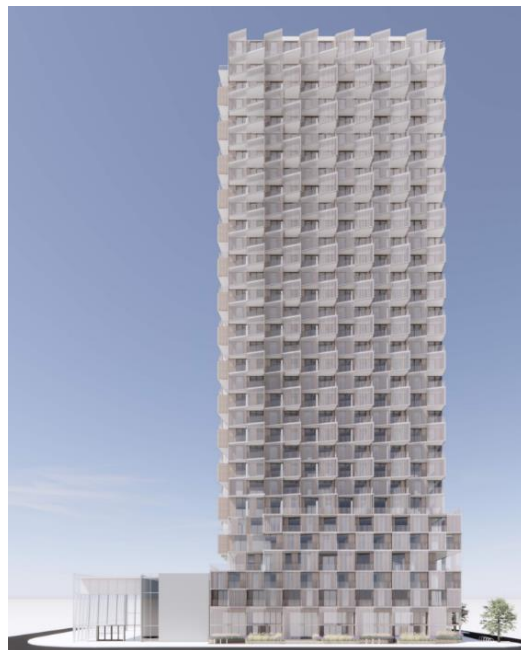

Figure 1 – Proposed Development Concept¹

¹ Development Concept image taken from drawings by gh3* dated October 26, 2022

1.2 PURPOSE OF THIS REPORT

The purpose of the Energy Strategy Report is to identify opportunities for the project to contribute to the City's objectives in reducing energy consumption and GHG emissions and increasing resiliency. The City of Toronto has developed a number of sustainability policies in order to address climate change, with particular focus on net-zero development and energy resilience. For developments greater than 20,000 sq.m. or within a Community Energy Plan area approved by Council, the City of Toronto has introduced the requirement for an Energy Strategy Report. The intent of the report is outlined in the Energy Strategy Terms of Reference and encourages projects to:

- Take advantage of existing or planned energy infrastructure, passive design, and renewable energy
- Consider energy sharing for multi-building developments
- Consider increased resiliency such as strategic back-up power capacity
- Identify innovative solutions to reduce energy consumption
- Explore engaging private investment in energy sharing systems

While some of these are outside the scope of the developer, or the project level, they have been incorporated into this report as applicable for the benefit of the design team.

Although these strategies are discussed and identified during re-zoning at high level, they can be further developed during the SPA process in combination with TGS requirements to inform design.

1.3 HOW TO READ THIS REPORT

The goal of this report is to present a roadmap of performance towards net zero by 2028 as well as additional sustainability measures that relate to energy performance. This intent of this report is not to hold developments accountable to the energy and resiliency strategies discussed within. It is worth noting that this project is in the early stages of development and that design decisions further down the line may result in the strategies in this report becoming more, or less, feasible.

Following this introduction, the report is organized into seven additional sections, each of which can be read as its own stand-alone chapter.

- SECTION 1 gives an overview of the Toronto Green Standard requirements and the energy targets evaluated within this report;
- SECTION 2 outlines the predicted energy performance of the project in steps towards a near net-zero performance and provides an overview of the recommended design alternatives that should be considered to meet each of the scenarios reviewed as well as design best-practices such as future-proofing;
- SECTION 3 explores project specific opportunities for the project during construction and post-occupancy including connections with third party energy suppliers and Toronto Hydro;
- SECTION 4 explores renewable energy;
- SECTION 5 identifies how to approach embodied carbon on the development and strategies to reduce embodied carbon;
- SECTION 6 explores financial incentives;
- SECTION 7 indicates the preferred scenario, exploring operational performance, embodied carbon, and financial impacts;

- SECTION 8 provides recommended next steps;
- THE APPENDICES provide additional detail on predicted performance, additional design guidance, information on designing for resiliency, and additional higher TGS Tier considerations.

1.4 TORONTO GREEN STANDARD - NEAR ZERO EMISSIONS DEVELOPMENT

Version 4 of the TGS came into effect on May 1, 2022, with energy targets aligned with the City of Toronto framework requiring near zero emissions levels for all new developments by 2028. This is done by increasing performance levels every 4 years. In all cases, Tier 1 is mandatory for all new developments in the city, while Tier 2 and above are optional increased performance levels incentivized with a development charge refund.

The energy requirements for Mid to High-Rise Residential & All Non-Residential development are outlined in the City of Toronto Zero Emissions Building Framework², and include the following three metrics:

Energy Use Intensity – EUI – ekWh/m^2 – Annual building energy use, divided by modelled floor area

Thermal Energy Demand Intensity – TEDI – kWh/m^2 – Annual heating load, divided by the modelled floor area. TEDI excludes the effects of mechanical efficiencies (e.g. condensing boilers) but does include passive systems such as air heat recovery, solar gains, and internal gains.

Greenhouse Gas Intensity – GHGI – $\text{kgCO}_2\text{e/m}^2$ – Annual greenhouse gas emissions, divided by the modelled floor area. The annual average carbon emission factors currently listed in OBC SB-10 (2017) are used for this calculation.

²<https://www.toronto.ca/wp-content/uploads/2017/11/9875-Zero-Emissions-Buildings-Framework-Report.pdf>

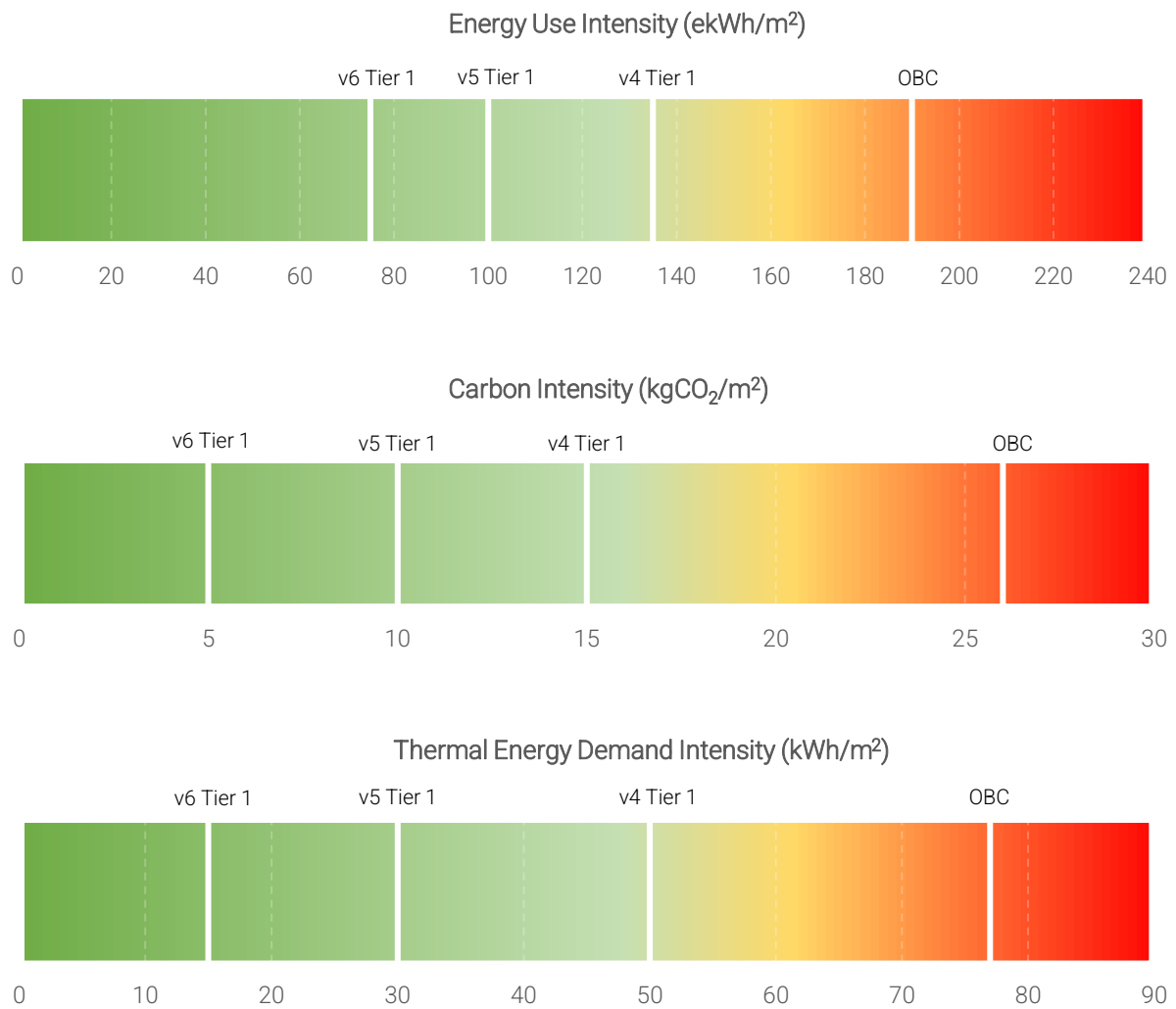

Figure 2 - TGS Performance Targets Over Time

1.5 DEVELOPMENT SPECIFIC ENERGY TARGETS

In line with the City of Toronto’s Terms of Reference, this report identifies design solutions in order to achieve Tier’s 1, 2 and 3 of TGS version 4, building to a *Near Zero Emissions* level of performance reflected by TGS v4 Tier 3.

It should be noted that minimum performance targets are determined by the date of SPA submission for a development, or phase of development, based on a 3-4 year cycle. The initial SPA submission is joint with the rezoning submission, therefore the project is subject to TGS v4 performance targets. Based on project specific timelines, the anticipated minimum performance requirements of this project are outlined in Table 1, indicated by phase.

Table 1 - Anticipated Minimum Performance Levels of the Development

Phase	Projected SPA Date	Minimum Performance Requirement		
		EUI (ekWh/m ²)	TEDI (ekWh/m ²)	GHGI (kgCO ₂ e /m ²)
1	2022	135.0	50.0	15.0

In line with Greenhouse Gas Intensity requirement of the TGS, predicted greenhouse gas emissions as well as predicted energy use will be presented. Referencing TGS version 4, a factor of **0.030 kg CO₂e/kWh** for grid supplied electricity, and **1.899 kg CO₂e/m³** for natural gas will be applied. When determining TGS compliance, a CWEC (Canadian Weather year for Energy Calculation) weather file for Toronto for 2016 or later must be used. Projects are also encouraged to also use a predictive future weather file when using an energy model to assess changes in performance over the expected life of the building. In this report, the impact of future climate will be discussed at a high level.

The contents of this report will explore a number of design scenarios for the 2634, 2636, 2640, 2642 and 2654 Eglinton Avenue West and 1856 and 1856A Keele Street project, with details on how to achieve them, as well as benefits including increased resiliency, potential for high performance certifications, and potential mitigated carbon pricing risks.

2. ENERGY ANALYSIS

2.1 PROJECT TGS PERFORMANCE

The City of Toronto *Zero Emissions Building Framework* outlines sample designs that were used in setting the targets for future versions of the TGS by end use and by building type. While this information has been used to set the minimum performance requirements, it only demonstrates a single generic path to TGS compliance. As such, EQ has used an internally developed archetype model to prepare suggested design packages for each scenario.

Predicted energy use and resulting carbon emissions for each of the design scenarios is presented in Table 2.

Table 2 - Predicted Energy, Thermal Demand and Carbon Performance³

	Scenario 1	Scenario 2	Scenario 3
Target Energy Intensity - (ekWh/m²)	135.0	100.0	75.0
Energy Intensity - (ekWh/m²)	111.6	99.3	74.3
Total Energy (eMWh)	2,968	2,641	1,977
% Savings vs Scenario 1	-	11%	33%
Target GHG Intensity (kg CO₂e/m²)	15.0	10.0	5.0
GHG Intensity (kg CO₂e/m²)	9.5	6.1	2.2
Total GHGs (tonnes CO ₂ e)	253	162	59
% Savings vs Scenario 1	-	36%	77%
Target Thermal Energy Demand Intensity (ekWh/m²)	50.0	30.0	15.0
Thermal Energy Demand Intensity (ekWh/m²)	45.8	29.9	14.6
Total Thermal Demand (eMWh)	1,218	795	388
% Savings vs Scenario 1	-	35%	68%

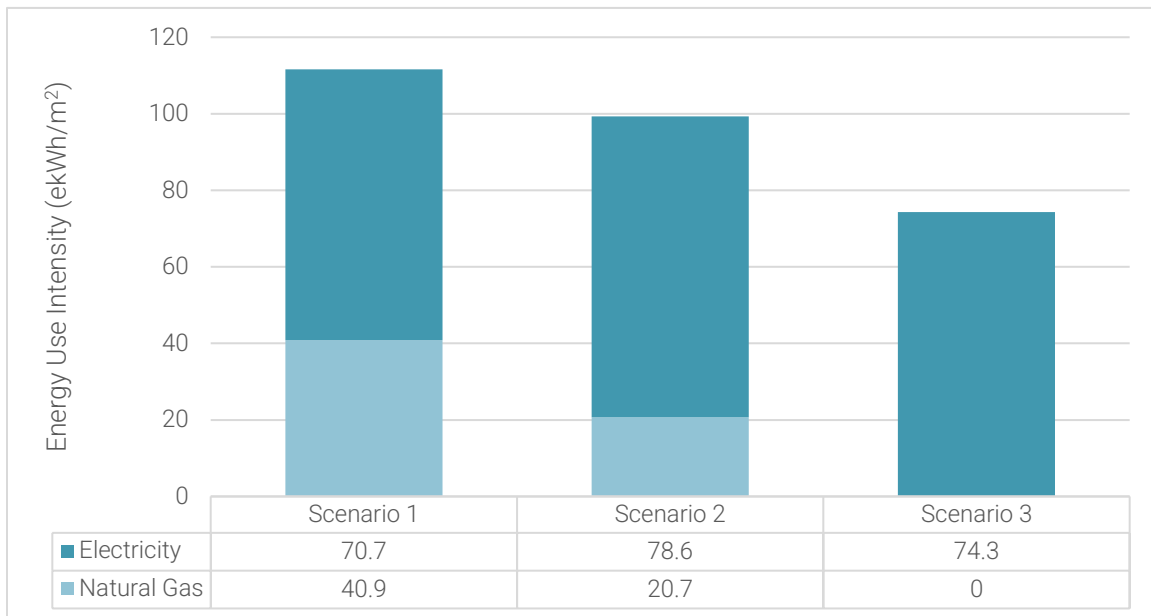

Figure 3 - Predicted Energy Consumption by End-Use

³Detailed calculations are available in the softcopy submission in the excel file provided with submission.

2.2 BUILDING LEVEL DESIGN OPPORTUNITIES

To optimize building performance, best practice is to prioritize passive design improvements to reduce thermal loads within the building. Once loads are reduced, the mechanical systems can then be designed to minimize the energy needed to meet those loads. Finally, renewable technology and carbon offsets can then be used to deliver net zero performance.

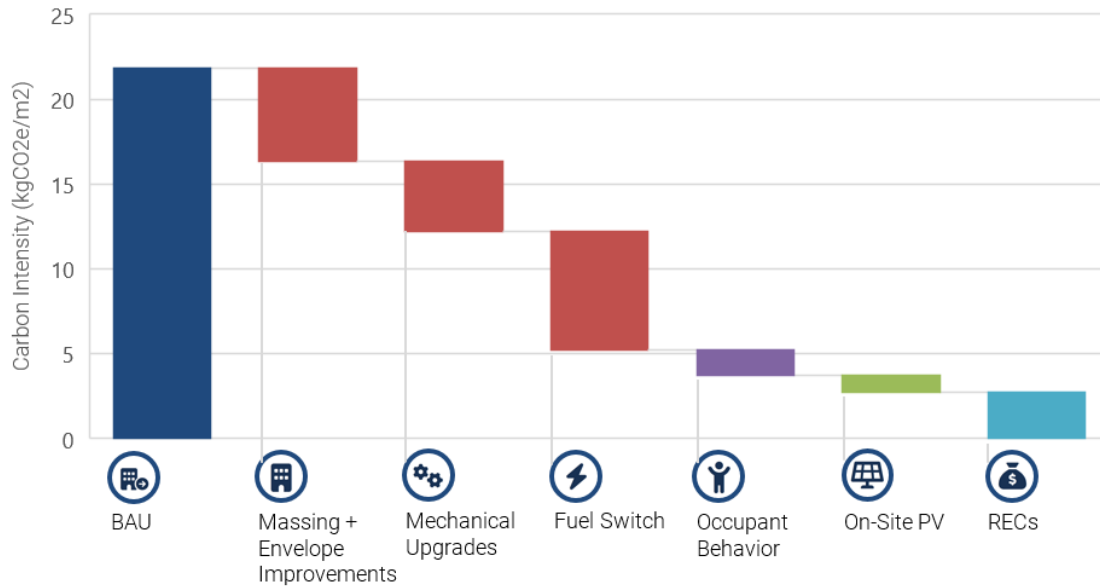

Figure 4 – Key Design Strategies

For the purposes of this report, sample design packages for each scenario have been prepared. Details of each design package can be found for review and comparison in Appendix B. Strategies to achieve each Tier will be discussed in detail below.

2.3 MASSING + ENVELOPE IMPROVEMENTS

As design progresses through ZBA, Site Plan Approval and building code review, the design teams will need to consider a number of passive design measures. In Table 3, basic guidance on what will likely be required for the various TGS targets is outlined.

Table 3 - Passive Design Considerations

Energy Conservation Measures	Necessity for Compliance			Design Decision Timing	Estimated Cost Premium
	v4 Tier 1 (2022)	V5 Tier 1 (2025)	V6 Tier 1 (2028)		
Opaque Wall					
Continuous insulation	+++			Design Development	\$6-9/m2
Improved thermal bridging detailing	+++			Design Development	Low
Massing optimization ⁴	+	++	+++	Concept	None
Reduced and/or thermally broken balconies	++			Schematic Design	None / \$285/m balcony length
Increased roof insulation	++			Design Development	\$6-9/m2
Improved air tightness	n/a ⁵	++		Design Development	Low
Fenestration					
Maximum 40% vision to wall ratio	+++			Schematic Design	None
High performance double glazed assembly, thermally broken aluminum frame	Likely not sufficient			Design Development	None
High performance double glazed, double low-e assembly, thermally broken aluminum frame	++			Design Development	\$54/m2
Standard triple glazed assembly, thermally broken aluminum frame	+++			Design Development	\$160/m2
High performance triple glazed assembly with fiberglass frame	+	+	+++	Design Development	\$200-500/m2

Based on current architectural drawings and discussions with the 2634, 2636, 2640, 2642 and 2654 Eglinton Avenue West and 1856 and 1856A Keele Street design team, the envelope is still being designed though a 60% vision glazing ratio is being targeted with significant balcony perimeter. To keep a traditional double-glazed assembly, the opaque wall needs to include significant amounts of continuous insulation. Though it may not be required, the project team is encouraged to explore thermally broken balconies. Based on initial

⁴ For example, may include outset rather than inset balconies, simplified floorplate geometry, reduced setbacks, and consolidating glazing to reduce framing area.

⁵ Credit can't be taken at site plan approval stage as post-construction verification is required via a whole building air tightness test.

thermal bridging calculations for the project, more than half of the thermal losses through the building envelope are through the proposed balconies.

If the project does decide to pursue higher tiers of performance, triple glazing and a reduction in the amount of glass should be explored. Relying on infiltration savings are only suggested for a near net-zero scenario. Infiltration savings of 25% are likely required to meet the Tier 3 requirements. Air tightness testing is new to the Toronto market and required for projects pursuing Tier 2. The design team should consider proactively doing air tightness testing and targeting 2 L/s/m² at 75 Pa.

2.3.1 PASSIVE DESIGN BEST PRACTICES

Building Massing

Building form and complexity can influence energy use within a building by directly impacting building heating and cooling loads. While a number of design elements can be later retrofitted to reduce energy consumption, the massing of the building generally will not change post-construction. As such, it's imperative that the massing is designed with intention.

More wall area per unit of floor area translates to more thermal loss per square meter, or TEDI, a key metric for TGS. Through internal investigation, EQ has found that a difference in a building's compactness ratio of 13% lead to influencing TEDI by more than 20%.

Table 4 – Building Compactness TEDI Impact

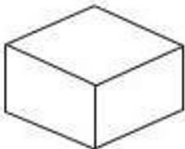
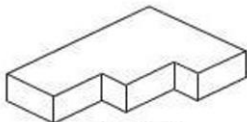
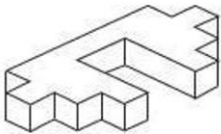
			
	Compact Design	Typical Design	Articulated Design
Floor area : Wall area Ratio	41%	48%	54%
TEDI (kWh/m ²)	55.8	62.5	71.7
Difference from Typical TEDI	-10%	-	+14%

Based on currently available drawings, the 2634, 2636, 2640, 2642 and 2654 Eglinton Avenue West and 1856 and 1856A Keele Street project has a compactness ratio of **46%**. For comparison, the TEDI metric of the TGS was designed based on a building archetype with a compactness ratio of 40%.

Some strategies to developing a more compact building design include:

- Reduce amount of inset balconies on the building.
- Where inset balconies are present, limit depth.
- Create a simplified floor plate with reduced protrusions.
- Create larger floor plates. Tall, thin towers inherently have a higher compactness ratio.

While this report focuses on energy and carbon savings, a number of other design factors can also be impacted by building massing. The University of Toronto has released a MURB Design Guide⁶ that outlines a number of massing considerations which also address access to daylight, future design flexibility, connectivity, and more. Some design decisions may increase access to daylight, but negatively impact energy performance. As such, careful consideration should be taken when designing the massing. While the study largely focuses on MURBs, many of the design considerations apply to all high-rise buildings.

Access to Daylight

- Orient buildings so that the longest elevation faces the south.
- Set the building back to reduce self-shading.
- External shading devices should be designed to reduce glare and overheating.
- Narrow floor plates provide more access to daylight.
- Use light shelves to reflect daylight deeper into the unit.

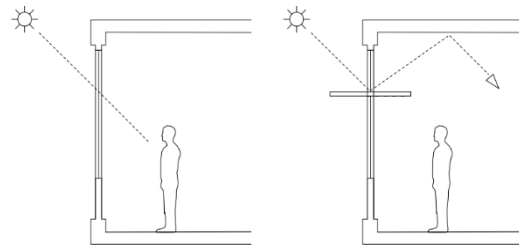

Design Flexibility

- Minimize shear walls to allow for future combined units and design flexibility.
- Provide various sizes of units/tenant spaces to attract various clientele.

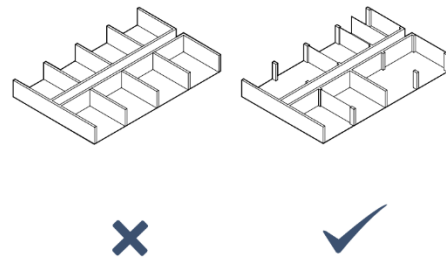

Additional Considerations

- Organize internal space and operable window placement to optimize natural ventilation opportunities.
- Use thermal mass to self-regulate building temperatures.
- Consider enclosing balconies to create a thermal buffer and increase time that tenants can comfortably use the balcony area.

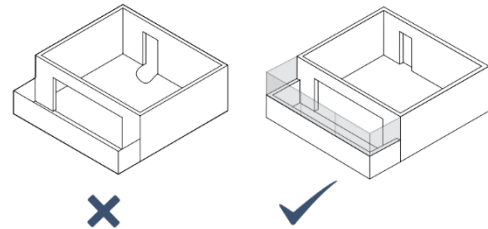

Figure 5 - Design considerations from the UofT Design Guide⁶

⁶ https://pbs.daniels.utoronto.ca/faculty/kesik_t/PBS/Kesik-Resources/MURB-Design-Guide-v2-Feb2019.pdf

Opaque Envelope

The opaque building envelope has significant impact on the passive design of the building and significantly impacts the thermal loads of, and thermal comfort within the building. Over the lifetime of a building, it is likely that only a single retrofit to the building envelope will occur. If thermal performance of the building envelope is prioritized, the extent of future retrofits can potentially be minimized.

Figure 6 demonstrates the impact thermal bridging has on opaque envelope performance. The thermal bridging impact of repetitive elements such as structural studs and spandrel back pans have been reflected in the building code for several years, and greatly reduce the effective performance of the wall as seen in Figure 6. However, poor envelope detailing at building interfaces, which traditionally have been ignored in energy performance codes, can be seen to have an even greater sum impact.

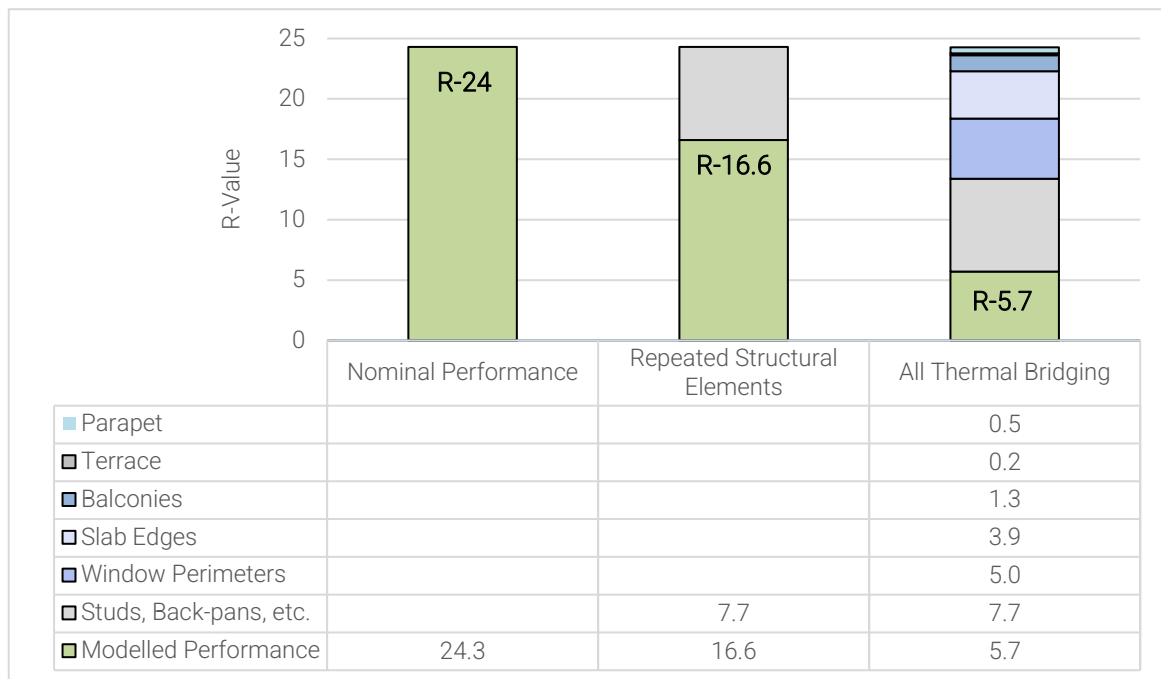

Figure 6 - Impact of Thermal Bridging on Opaque Envelope Performance⁷

⁷ The nominal performance of the building envelope is the sum thermal performance of the clear wall materials in the building envelope. It does not account for any thermal bridges.

Three key strategies to improving the opaque building envelope performance and their relative priority are:

Best **Reduce the number of thermal bridges** – The best way to lessen the impact of thermal bridging on the opaque wall is to reduce the number of bridges. Reducing protrusions eliminates corner intersections and allows for larger opaque wall areas. Reducing balcony areas by using cantilevered rather than inset balconies, or even eliminating balconies can significantly improve envelope performance. Using larger glazed areas reduces window perimeters which improves both the opaque and glazing performance.

Better **Improve thermal bridge performance** – Once the number of thermal bridges has been reduced, taking effort to improve the ones remaining is important. BC Hydro has developed a *Building Envelope Thermal Bridging Guide* which includes a vast library of sample architectural details ranging from poor to efficient which can be used as a guide to improving bridge details.

Good **Improve the clear wall performance with continuous insulation** – While it may seem like increasing the clear wall performance would be a priority, the building envelope is only as strong as its weakest links; namely it's thermal bridges. A poor thermal bridge will have a much more devastating effect the greater the clear wall performance is. Once the bridges have been dealt with, improving the amount of insulation, especially continuous insulation in the clear wall will truly maximize opaque wall performance.

Special consideration should be given to the thermal bridging impact of architectural details to achieve the thermal demand requirements of TGS v4, which may not have been previously prioritized. Architectural details which in our experience have the biggest impact, as well as sample thermal bridging details from the *Building Envelope Thermal Bridging Guide (BETBG)* where relevant, are listed below, to provide an indication of the relative impacts of these decisions.

Opaque Wall and Glazing Interfaces

Glazing interfaces refers to the architectural detail where a glazing system connects to an opaque wall. In panelized systems, the glazing interface thermal bridging is already accounted for in the framing of both the spandrel and vision glazing performances. When working with non-panelized systems however, this interface can translate to significant thermal bridging on a project.

As a first step, this interface should be minimized by using larger single windows. This results in less length of glazing interface compared to multiple smaller windows, even if the same amount of glass is provided.

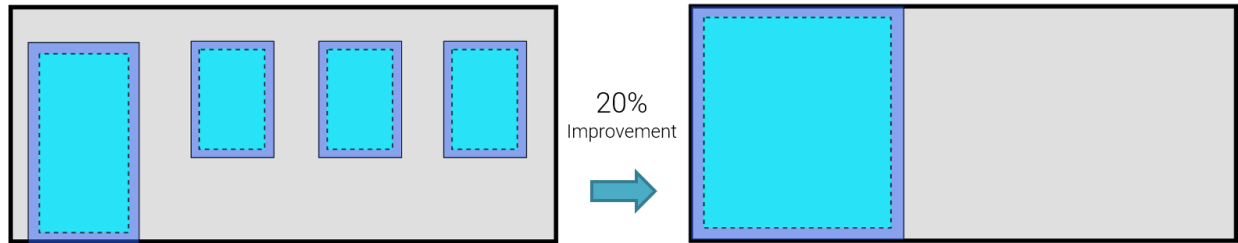
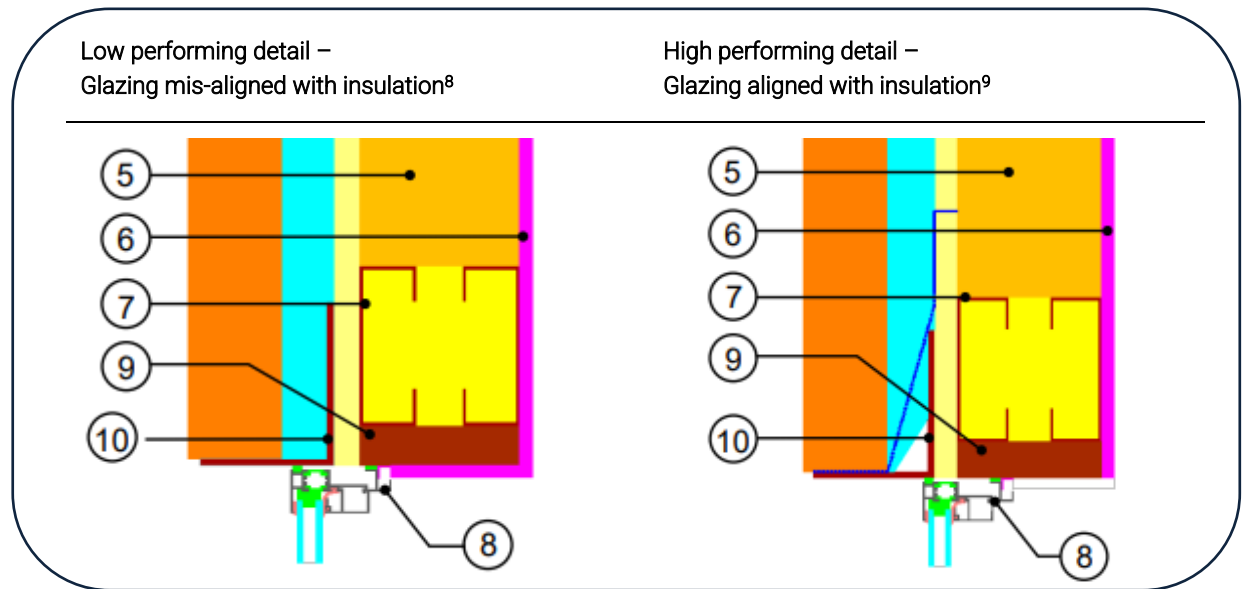

Figure 7 - Potential improvement Through Passive Glazing Design

Once minimized, framing should be thermally broken, with the break aligned with the insulation layer in the opaque wall. In the sample details shown below, **a 66% reduction in thermal losses can be achieved by aligning glazing with insulation in the opaque wall.**



⁸ [BETBG Detail 5.3.8](#) – Interior Insulated Steel Frame Wall Assembly with Brick Cladding – Window Intersection

⁹ [BETBG Detail 5.3.9](#) – Interior Insulated Steel Frame Wall Assembly with Brick Cladding – Window Intersection Aligned with Insulation

Interior and Exterior Wall Interfaces & Corners

When detailing interior and exterior wall interfaces and corners, one of the most important things to consider is constructability. Maintaining the air barrier and continuous insulation layer along interior walls and structural elements such as columns and shear walls can lead to notable improvements in the envelope.

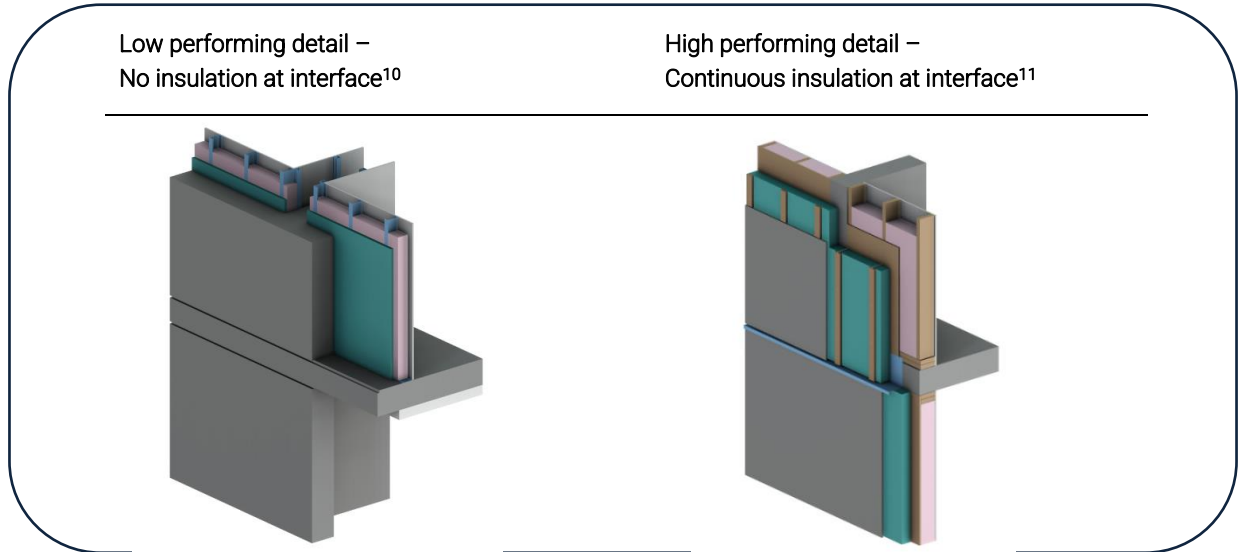

Slab Bypasses

With certain wall assemblies, maintaining the insulation layer over the slab edge can be difficult, if not impossible to achieve due to how those walls are assembled. For example, in a window wall assembly, it may only be possible to fit 1-2 inches of firestop insulation between the panel and slab edge, significantly reducing the effective performance of the wall. Consideration should be given to using a curtain wall or a non-panelized system like EIFS over a window wall system, as these assemblies hang in front of the slab, resulting in additional room available to maintain the insulation layer. In the sample details shown below, **a 79% reduction in thermal losses can be achieved from the high performing detail.**

¹⁰ [BETBG Detail 7.7.1](#) – Exposed Interior Concrete Mass Wall Intersection with Non-Insulated Partition Wall Intersection and Unheated Intermediate Concrete Floor (Parking Garage). Interior Wall at Intermediate Concrete Floor

¹¹ [BETBG Detail 8.7.1](#) – Exterior and Interior Insulated Wood Infill Wall Assembly with Wood Strapping and Continuous Insulation Supporting Fibre Cement Board and R-19 Batt Insulation in Stud Cavity – Concrete Wall and Intermediate Floor Intersection with Flashing Bypassing Exterior Insulation

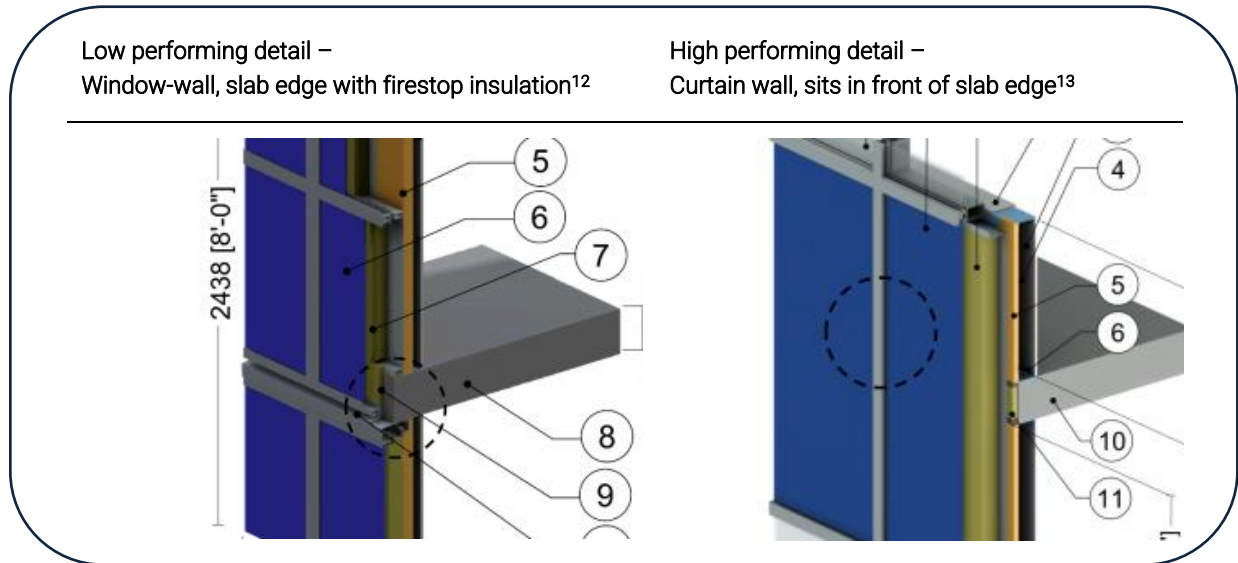

Depending on the project design, the cladding over the slab edge may be much smaller in size further reducing the panel performance. Using a larger panel can help improve performance of the slab edge condition as a whole.

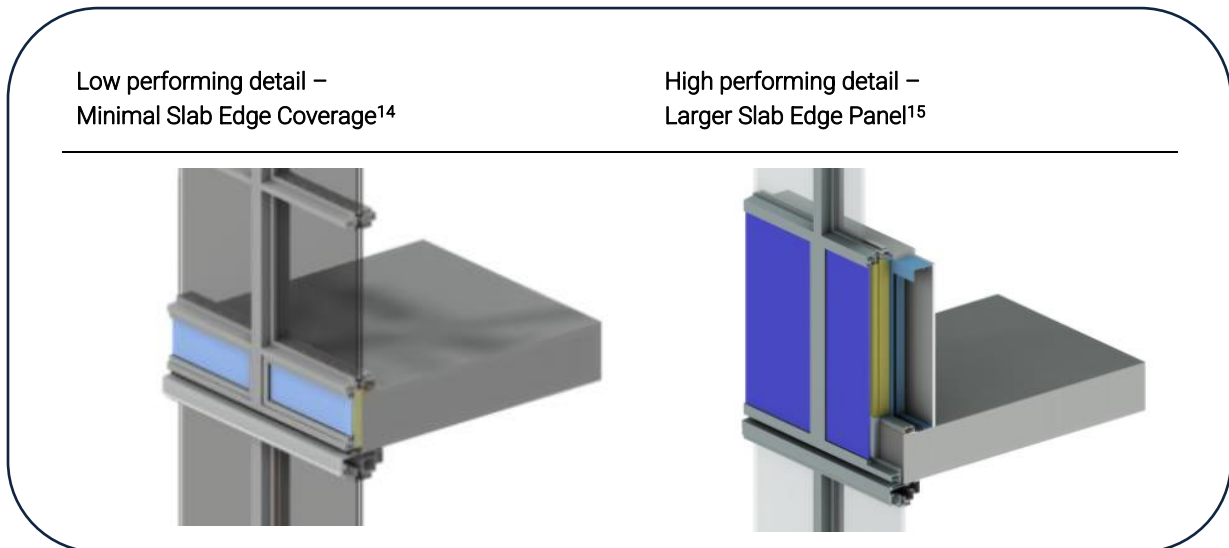

¹² [BETBG Detail 1.2.6](#) – Window-Wall Bypass at Full Height Spandrel Section with Interior Spray foam Insulation

¹³ [BETBG Detail 4.2.2](#) – Spandrel Section at Intermediate Concrete Floor with High Performance Curtain-wall System with Interior Spray foam Insulation

¹⁴ [BETBG Detail 1.2.10](#) – Window Wall System with Full Height Vision Section – Intermediate Floor Intersection with Spandrel Bypass and no Interior Stud Cavity Insulation

¹⁵ [BETBG Detail 1.2.1](#) – Window-Wall Bypass at Spandrel Section without Interior Sprat foam Insulation

Balconies & Terraces

Balconies are often the weakest performing element of the opaque building envelope. With a poor envelope design, the decrease in R-value may seem minor, however, as clear wall R-values increase, **balconies can reduce effective R-value by more than 25%**. While minimizing balconies is ideal, there are some design alternatives that can be considered.

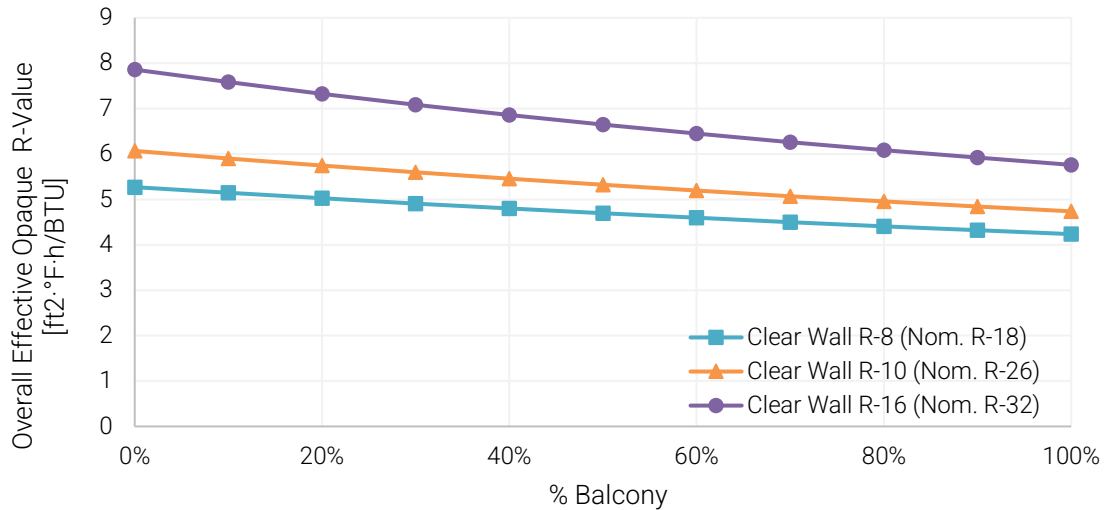
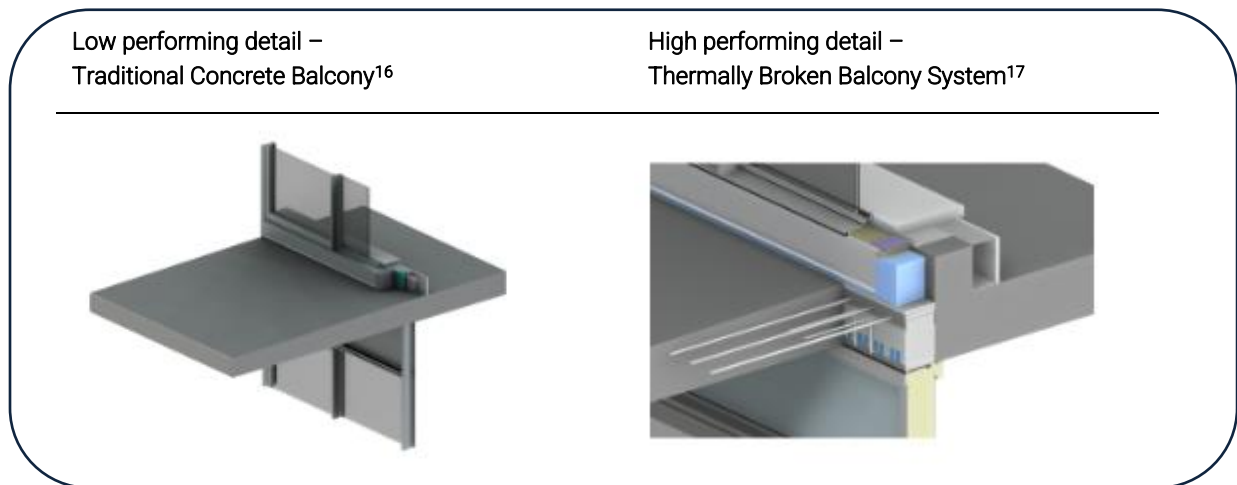

Figure 8 - Impact of Balcony on Thermal Performance

The length of balcony penetrating through the envelope can be minimized while maintaining the overall balcony area by using cantilevered balconies rather than inset balconies. This will also reduce the number of corners in the building envelope, another element of thermal loss in the opaque wall. Additionally, a thermally broken balcony design can be used. From the BETBG, **a 74% reduction in thermal losses can be achieved by thermally breaking balconies.**



¹⁶ [BETBG Detail 9.1.3](#) – Interior Insulated Curb and Exposed Concrete Floor at Sliding Door

¹⁷ [BETBG Detail 9.1.15](#) – Window Wall System with Spandrel Panels and Sliding Door – Scöck Isokorb KXT15-V6 Thermal Break at Concrete Balcony and Curb Intersection

Thermal breaks are often used to improve the performance of balconies, but they are not the only solution. Smaller buildings can consider using pillars to externally support the balconies, reducing or even eliminating the concrete penetrating through the building envelope. Prefabricated solutions can also be used as a ‘bolt-on’ solution to reduce the thermal losses from balconies.

Parapet

While parapets are typically a smaller portion of the thermal losses in an envelope, performance should still be improved where possible. In best practice, roof insulation should be wrapped around the parapet and ideally connect to the opaque wall insulation so that the insulation is continuous. At the highest levels of performance, thermal breaks can also be considered for parapets.

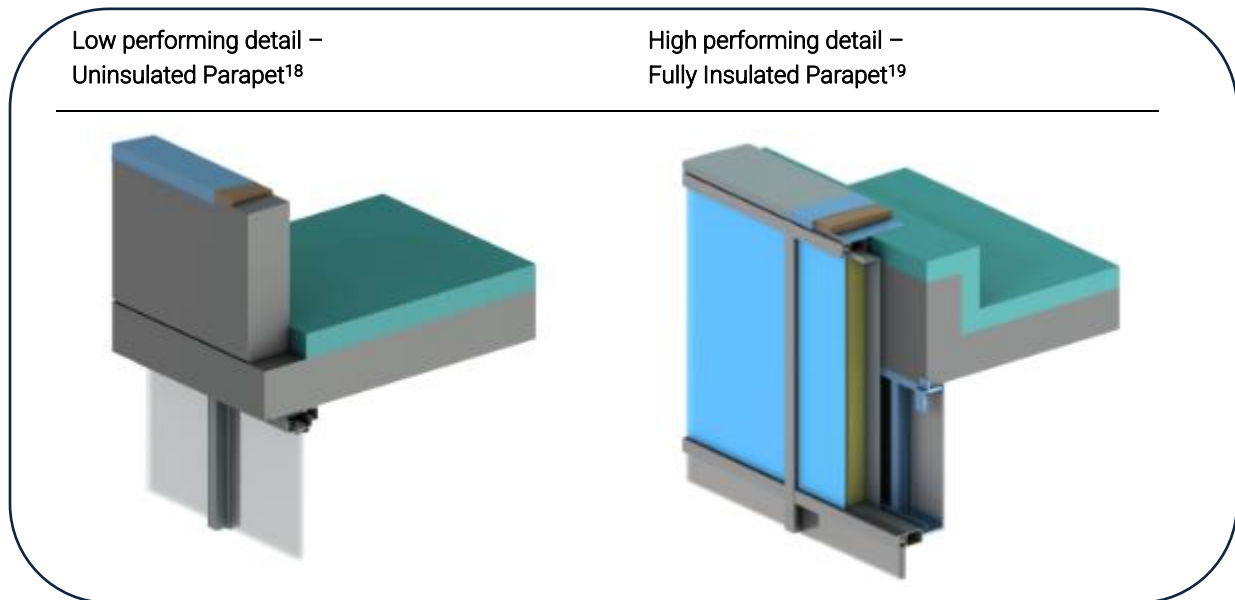

Fenestration

As mentioned with the opaque envelope, over the lifetime of a building, it is likely that only a single retrofit to the building envelope will occur. Opaque wall retrofits can have significant cost implications for a project. If thermal performance of the building envelope is prioritized, the extent of future retrofits can likely be minimized.

A traditional high performance double glazing assembly will likely not be acceptable for meeting TGS v4 minimum targets. In order to achieve the minimum requirements of TGS, increased performance double glazed double low-e coated glazing, or triple glazing should be considered. An envelope consultant should be retained to assess differing glazing scenarios. Depending on the desired solution, design considerations may be required to avoid downdraft discomfort for taller windows and to eliminate the potential for condensation.

When choosing a glazing product, it is important to consider not only the thermal performance but the solar heat gain coefficient (SHGC) as well. A higher SHGC will result in more solar gains and allow for passive

¹⁸ [BETBG Detail 1.3.1](#) – Exposed Concrete Parapet at Window-Wall with Concrete Roof Deck

¹⁹ [BETBG Detail 2.2.4](#) – Exterior Insulated Concrete Parapet with Curtain-wall Outboard of Parapet and Concrete Roof Deck

heating, reducing the thermal demand; while a lower SHGC will reduce over-heating in shoulder seasons and reduce cooling loads in the summer.

Reduced glazing areas however will reduce both heating and cooling loads within the building. A glazing to wall area ratio of 35% to 40% is often considered optimal, and will help optimize the performance of the building envelope while maintaining occupant views, daylight access, and improved thermal comfort.

Consideration should be given to the potential changes in climate over the lifetime of the building rather than just the current climate in which the building envelope was designed. With climate change, heating loads are decreasing and cooling loads are increasing in our climate. One option to balance glazing performance may be electrochromic glazing (glass that tints in response to solar intensity or sun position), which can maximize daylighting and views in regularly occupied spaces as well as have a positive impact on the building cooling and heating loads.

Air Tightness Testing

While there are no requirements for air tightness testing for TGS Tier 1 developments, higher tiers of performance require an air tightness test to be performed. There are two types of whole-building air tightness testing; envelope testing and operational testing. Envelope testing involves sealing all external ducts, with results focused on the envelope air leakage. Operational testing keeps external ducts open and aims to give a better understanding of air leakage during day-to-day operations.

TGS Tier 2 and higher require developments to perform an operational test and target a leakage rate of 2.0 L/s/m² at a 75 Pa pressure differential. Decreasing air leakage in the building leads to less heat loss, directly impacting energy performance. While there is no penalty for not meeting the target, projects are able to claim energy savings after testing verification. At higher levels of TGS, reductions in air leakage are likely required to achieve the high performance targets.

There are two approaches to air tightness testing which each have their own opportunities and risks; whole building and guarded testing. For projects with staged occupancy guarded testing is generally most advantageous. A detailed summary of each approach can be found in Table 5.

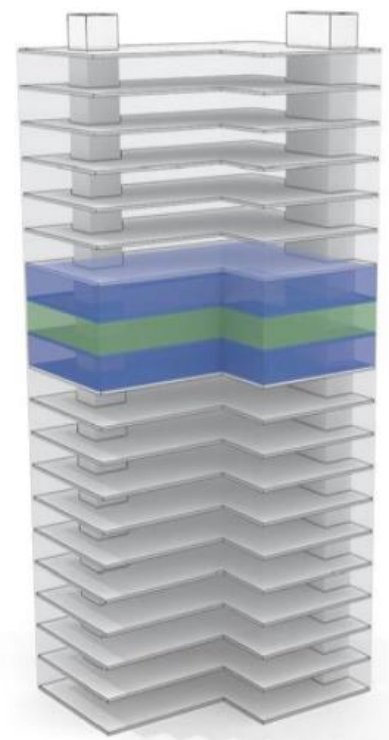

Figure 9 – Diagram of Guarded Testing²⁰

²⁰ https://obec.on.ca/sites/default/uploads/files/newsletter/Pushing_the_Envelope_Fall2019-article9.pdf

Table 5 - Summary Overview of Air Tightness Testing Requirements

	Whole – Building Testing	Guarded Testing
Construction Completion	Construction of enclosure must be complete	Only test floor and two adjacent floors need to have enclosure completed
Ease of implementing changes	Results aren't available until building is complete, modifications are difficult and costly	Results available as tests are done, modifications are much easier to implement
Occupancy requirements	Entire building cannot be occupied	Floors outside of testing can be occupied
Building Size	Great <25 stories, >25 stories, wind loading and stack effect can skew results	Best suited for buildings with a consistent floor plate, effective >25 stories
Effort	For large buildings, amount of equipment and level of effort required is significant	Effort generally not hugely impacted by building size
Popularity	More common and more recognized in the industry	Becoming more common

If performing guarded testing, the price will correlate with the number of tests required. Guarded testing is required at each unique condition throughout the building – for example, a test would be required for the podium and top floor as they have notably different designs. Based on the current design, it is estimated that 6 tests would be required for the 2634, 2636, 2640, 2642 and 2654 Eglinton Avenue West and 1856 and 1856A Keele Street development. Projects are encouraged to read the Toronto Green Standard v3 – Tier 2-4 Guidance Document Air Tightness Testing Protocol & Process²¹ for further details on testing requirements.

²¹ https://www.toronto.ca/wp-content/uploads/2020/01/8742-CityPlanning_TGSV3_ATT.pdf

When planning for testing, timing is key. Construction should be far enough along that firestops between floors are installed. Depending on construction progress, temporary partitions may be required to seal off unfinished areas such as elevator shafts. This can lead to tight timelines for testing which will require coordination with trades and may require tests to be performed on weekends.

There are a number of strategies that can help projects achieve their air tightness targets.

- The more unique conditions a building has, the more detailing that will be required by the architect to ensure the air barrier is continuous. Simplified design with a focus on constructability and a clear continuous air barrier is ideal.
- Efforts to reduce mechanical penetrations, such as choosing heat pump dryers, recirculating kitchen hoods, or centralizing ventilation.
- Where mechanical penetrations are present, using mechanical dampers over gravity dampers can help to ensure that dampers stay closed when fans aren't operating, reducing leakage.

From a preliminary analysis of air tightness testing in Seattle²², it was found that “the quality of detailing at interfaces and workmanship can have a much larger impact on the overall air leakage of a building than the air barrier type.”. Training for trades and the design team can significantly improve air tightness performance. Throughout design and construction, assigning an air tightness ‘champion’ to ensure air leakage is a priority can help ensure success as well. As construction progresses, mock-up tests of envelope components can be used to gauge air leakage early on and allow for revisions if necessary. If construction has advanced far enough that remedial measures are limited, some aerosolized building seals are available on the market to seal leakage points.

2.4 ACTIVE DESIGN MEASURES

Ventilation

Ventilation with fresh air is a significant factor contributing to building heating and cooling loads as well as building energy and carbon use. In a high-rise residential building specifically, corridor pressurization rates can vary greatly between buildings. When using lower corridor pressurization rates, ensuring a tight building envelope with reduced infiltration is required to ensure the building is properly balanced. Reducing exhaust requirements in suites will also help pressurization with lower corridor ventilation rates. This can be done through centralizing ventilation, using heat pump dryers, and installing recirculating range hoods. Once ventilation rates have been right-sized, using high efficiency heat recovery to further reduce energy use is a key design strategy in a high performing building. For non-residential areas with variable occupancies, occupancy sensors should be used to ensure spaces are not over-ventilated. Ventilation design considerations can be seen in Table 6.

²² <https://www.airbarrier.org/wp-content/uploads/2017/12/Building-Enclosure-Airtightness-Testing-in-Washington-State.pdf>

Table 6 - Ventilation Design Considerations

Energy Conservation Measures	Necessity for Compliance			Design Decision Timing	Estimated Cost Premium
	v4 Tier 1 (2022)	V5 Tier 1 (2025)	V6 Tier 1 (2028)		
Corridor ventilation – avg 30 cfm/suite	Likely not sufficient			Design Development	None
Corridor ventilation – avg 15 cfm/suite ²³	+++			Design Development	Low
Corridor ventilation – code minimum- requires compartmentalization to remove pressurization requirements	+		++	Design Development	\$130/suite savings
Code minimum ventilation in other areas	+++			Design Development	Low
Recirculating range hoods	+	++	+++	Design Development	Low
Ductless dryers	+	++	+++	Design Development	Low
65% Efficient air side heat recovery in suites	++	Likely not sufficient		Design Development	None
80%+ Efficient air side heat recovery in suites	+		+++	Design Development	!\$1,800-2,400 / suite
Corridor heat recovery	+	++	+++	Design Development	High

To achieve the project target, v4 Tier 1, ventilation rates throughout the building should be as close to minimum ASHRAE 62 ventilation rates as possible. In amenity, retail, and institutional spaces this may require demand controlled ventilation to be used. In residential corridors, EQ recommends pursuing 30 cfm/suite for pressurization. In all spaces aside from residential corridors, high efficiency heat recovery should be used, ideally via remote ERV with a minimum 65% effectiveness. This would be a premium efficiency ERV, likely remote, but will be required to achieve TGS targets with the currently proposed envelope design.

For higher tiers of performance, corridor ventilation should be lowered as much as possible. In EQ's experience, this equates to ~15 cfm/suite. For Tier 2, heat recovery units in suite should be high efficiency, and for Tier 3, heat recovery will also be required on the corridor ventilation unit in order to meet the targets. This would likely require centralizing ventilation as much as possible.

Domestic Hot Water

Domestic hot water use in high-rise residential buildings is typically one of the largest energy and carbon uses and savings that need to be targeted to achieve a high performance design. While domestic hot water loads can be reduced through low flow plumbing fixtures, there are limitations to how much impact this can have. At higher performance levels, a transition to a high efficiency electric heat pump heating source, or

²³ In order to maintain proper building pressurization, improved air tightness in the building envelope will be required.

incorporation of sewage or drain water heat recovery may need to be considered in order to meet the corresponding carbon and energy targets.

Table 7 – Domestic Hot Water Considerations

Energy Conservation Measures	Necessity for Compliance			Design Decision Timing	Estimated Cost Premium
	v4 Tier 1 (2022)	V5 Tier 1 (2025)	V6 Tier 1 (2028)		
20% reduction in plumbing fixtures flow	Likely not sufficient			Design Development	None
35% reduction in plumbing fixtures flow	+++		-	Design Development	None
Sewage / Drain Water Heat Recovery	++		+++	Schematic Design	\$1,700 / suite
Central domestic hot water heat pump	++		+++	Design Development	High
DHW Preheat from geothermal loop	+ ²⁴			Schematic Design	Low

Traditional domestic hot water design for large building uses a central natural gas plant. For Tier 1, this is sufficient in the design as a geothermal system is being used to aid with electrification. For high tiers of performance, putting the domestic load on the geothermal loop or using a domestic hot water heat pump for 50-100% of the peak domestic load will likely be required.

Mechanical and Other Opportunities

As design progresses, a preliminary energy model will be developed to evaluate different design opportunities to ensure an optimized active design. As minimum requirements and design goals shift towards low-carbon targets, high efficiency systems and electrification of designs will be required.

Some advanced design measures have been highlighted in the table below, and are more thoroughly detailed in Section 2.4.1 - Low-Carbon Energy Solutions; of this report.

Table 8 - Active Design Considerations

Energy Conservation Measures	Necessity for Compliance			Design Decision Timing	Estimated Cost Premium
	v4 Tier 1 (2022)	V5 Tier 1 (2025)	V6 Tier 1 (2028)		
Mechanical System					
Fan Coil system	+/-	Likely not sufficient – some fuel switch required		Schematic Design	None
Water Source Heat Pump system		+		Schematic Design	Low
Water-source VRF system		++		Schematic Design	Medium

²⁴ Heavily dependent on building load profile and balance.

Energy Conservation Measures	Necessity for Compliance			Design Decision Timing	Estimated Cost Premium
	v4 Tier 1 (2022)	V5 Tier 1 (2025)	V6 Tier 1 (2028)		
Air-source heat pump / VRF system	++		+++	Schematic Design	Medium
District Energy ²⁵	varies ²⁶			Schematic Design	Low
On-site Renewable Energy Generation	+		+++	Design Development	Low
Geothermal Energy	+++			Schematic Design	Low/High
Other Considerations					
EnergySTAR appliances	+++			Design Development	None
30% reduction in lighting power density	+++	-		Design Development	Low
50% reduction in lighting power density ²⁷	++	+++		DD	Medium

The project is currently planning on installing a geothermal system in-site which will help significantly with decarbonization efforts. The project should also incorporate EnergySTAR appliances and some moderate lighting savings. For higher tiers of performance, EQ would recommend fully electrifying the building. This will be further explored in Section 3.0.

2.4.1 LOW-CARBON ENERGY SOLUTIONS

The City of Toronto’s ambitious net-zero goal for buildings has been analyzed throughout this report. The design team is encouraged to incorporate design and construction strategies in line with this goal, which are designed to reduce electrical demand, carbon emissions and conserve energy compared to a more conventional design.

In the Near Zero Emissions design option, fuel switching occurs by replacing natural gas with electric heat pump based heating and domestic hot water in order to achieve the emissions reductions requirements, as well as aggressive improvements in building envelope thermal and air tightness performance. This is reflective of the net zero emissions mandate outlined by future versions of the TGS, as well as the higher GHG intensity of natural gas compared to the relatively low-carbon electricity grid in Ontario.

At this stage of design, low-carbon solutions are still under consideration. If a heat pump or VRF system is used, the high efficiencies achieved with these systems in combination with their electric heat pump based heating components will reduce the building’s carbon use by relying on the relatively clean Ontario electricity grid. This would represent a fundamental shift in the primary heating energy source of the building and the

²⁵ See Section 3 of this report for details on district energy analysis.

²⁶ Impact of district energy system is highly dependent on system efficiency and carbon factors

²⁷ Achieving lighting reductions in this range may require design changes to ensure minimum lighting levels are achieved such as strategic window placement and light coloured interior surfaces

resulting carbon impact. Back-up boilers for these systems should be high performance condensing or near-condensing technology, which will reduce carbon compared to traditional systems. Low-flow plumbing fixtures can also be used to minimize the domestic hot water boiler load, further reducing carbon use.

Several advanced energy design measures are listed for consideration below.

District Energy Systems

District energy system may be categorized as one of two types: **High Temperature** and **Low / Ambient Temperature**.

A **High Temperature** district energy plant provides heating and/or cooling to the building at the temperature required to meet the load, and involves using heat exchangers or coils *within* the building for distribution of heating and cooling, similar to a typical high rise design. This approach is amenable to district technologies such as Deep Lake Water Cooling (DLWC) and central steam or hot water plants, as well as central Combined Heat and Power (CHP) systems.

- Equipment in building may be minimized (boiler/chiller reduced to a heat exchanger)
- Distribution piping requires insulation
- Heating demand met by gas fired equipment or recovered waste heat
- High temperatures can be augmented by CHP / heat recovery
- Separate loops required for heating and cooling

In comparison, a **Low / Ambient Temperature** district thermal system takes its design philosophy from a water-loop heat pump (WLHP) HVAC system in a high rise residential building. The ambient temperature system relies on heat pumps or VRF units located in the space. These units connect to an ambient temperature (typically 12 to 30°C) distribution loop through which the heat pumps can reject or absorb heat. This approach is amenable to incorporating boreholes at a community level for ground source heat pump technology or low grade solar thermal.

- Heat pump equipment required in building to generate temperature for space conditioning
- No insulation needed / heat exchange with ground encouraged
- Heating demand met by terminal electric heat pump / VRF, and central gas fired or renewable sources
- Low temperatures amenable to ground loops / low grade solar thermal
- Heating and cooling provided by one loop

The decision to pursue either of these district energy options relies on several factors, including the availability of each type of system, willing partners (e.g. local public/private utilities), space constraints, and project goals.

Geothermal: A piping network which takes advantage of stable earth temperatures to provide heating in the winter and cooling in the summer typically coupled with heat pumps or VRFs in the space. As geothermal developments rely on balanced load profiles, a geothermal system may need to be supplemented to meet all loads. Installing geothermal could result in a reduction in thermal *energy* by approximately 50%. It is also a useful technology for decarbonization as it requires a fuel switch from gas to electricity for heating/DHW; helping immensely with the GHGI target.

Additional benefit to installing a geothermal system could include:

- Elimination of plant equipment, leading to lower maintenance and reserve fund costs
- Elimination of cooling tower water/chemicals as no cooling tower is required
- Reduction of utility costs

Air Source VRF: A high efficiency fully electric HVAC system that can operate at wider temperature ranges than a typical air source heat pump and utilize electric heating as a back-up source when required.

Sewage Heat Recovery: A specialized water-to-water heat pump that recovers energy directly from wastewater and uses this energy to preheat domestic hot water.

Solar Thermal: Rooftop mounted solar collector for thermal energy which is typically used to offset heating of domestic hot water loads in residential buildings. Similar to the constraints listed for solar PV panels, available rooftop space may be a constraint.

Solar Air Heater: Draws incoming air through a transpired solar collector for pre-heat of the central air handling unit, reducing the ventilation heating load. Integrated into the building envelope, they are typically located on mechanical penthouses for visual purposes and for proximity to the MPH. As such, available area may be limited.

Battery Storage: Can be utilized in buildings to provide zero carbon backup power, and empower owners to draw from the grid at off-peak times. Paired with renewable energy, battery storage can extend the utilization of renewables promoting a renewable, resilient grid.

Earth Tubes: Draws incoming air through tubing in the ground for pre-heating and cooling, reducing ventilation loads.

Off-site Renewable Energy Procurement: Aside from on-site renewable technologies, any development may procure off-site renewable energy generation credits to offset their carbon footprint.

2.5 ACTIVE DESIGN BEST PRACTICES

While designing the building to achieve a high level of performance is a requirement, actually achieving that high performance is neither regulated, nor guaranteed. There are many possible design solutions that can achieve the targeted level of performance and some additional strategies that can help safeguard both the initial delivery and ongoing operational performance of a high performing building.

Future-Proofing

While some of these solutions are ideally incorporated into the building during initial design, that may not be feasible for every project. Where it isn't feasible, the City of Toronto has produced a *Mechanical System Design Guidelines for Low Carbon Buildings*²⁸, which provides a summary of design strategies to future-proof building designs for the changing climate. Some of these solutions include:

²⁸ <https://www.toronto.ca/wp-content/uploads/2022/02/9441-2021-11-29Low-Carbon-Thermal-Energy-Ready-Buildings-AODA.pdf>

- Install heating and cooling plant equipment on the lower levels for easier integration into a future district system, or provide for future connection points into the building’s thermal piping at ground level
- Provide adequate space at or below ground level for a future energy transfer station
- Provide an easement between the mechanical room and the property line to allow for thermal piping
- Provide two-way pipes placed in the building to carry thermal energy from the district energy network to the section in the building where the future energy transfer station would be located
- Size heating and cooling risers to convey the design load from the penthouse to the below grade chiller plant
- Install a low temperature hydronic heating system (e.g. heat pump loop) that is compatible with a district energy system in order to reduce the pipe sizes and associated valves, fittings, etc.
- Where a below-grade chiller plant isn’t feasible, allocate additional roof space, structural support, and power supply for the future allowance of air-source heat pumps.

Incorporating these elements into the initial design can improve efficiency in the near-term and future-proof the building for later retrofit opportunities.

Cooling Energy Demand Intensity

Given that Toronto is in a cold climate, current passive building design practices emphasize reducing heating loads. Further investigation into the Cooling Energy Demand Intensity (CEDI), however, has revealed that buildings also have significant cooling loads that, if left unattended, can have as large an impact on thermal comfort as TEDI.

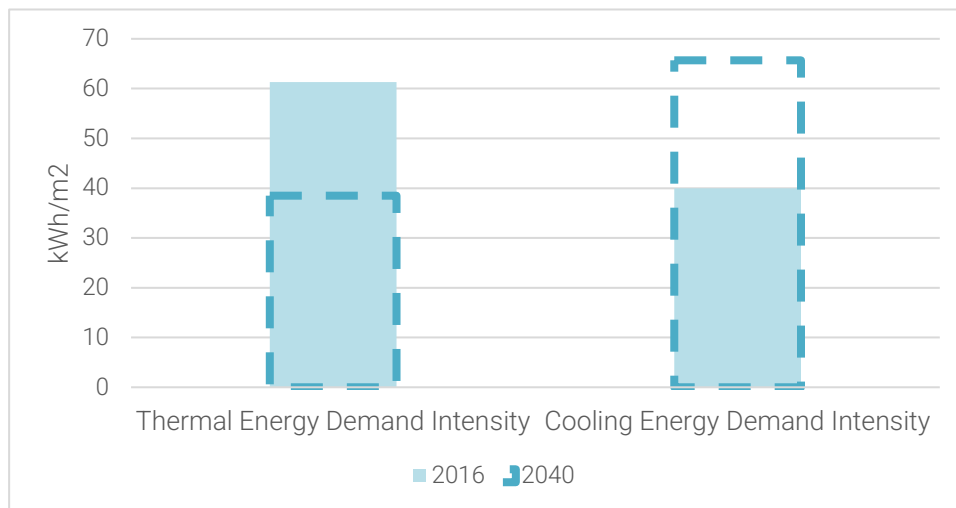

Figure 10 – Sample Comparison of Modelled Heating (Thermal) and Cooling Energy Demand Intensities over Time

EQ undertook an investigation of the impacts of TEDI and CEDI by looking at a sample set of our modelled buildings in Toronto, and comparing how the building use energy under both the current weather patterns and the future weather patterns anticipated for the 2040s. In doing so, it became apparent that the climate in Ontario will shift to a cooling-dominated environment. For this sample set of modelled buildings, the **TEDI decreased by 35% and CEDI increased by 70%** over the lifetime of the building. This shift indicates that heating equipment will become over-sized, potentially leading to performance issues and redundancy. Cooling equipment will conversely become undersized and require replacement sooner to increase capacity, or run the risk of potential thermal comfort issues.

Some challenges for reducing/controlling CEDI in MURBs are:

- Lighting and tenant plug-loads provide internal heat gains to the space and are typically dependent on tenant lifestyle, rather than building design and performance
- An improved opaque envelope may actually increase the cooling load of the building by trapping more heat when it's not desirable (e.g. shoulder seasons)
- Factors such as reducing the solar heat gains through glazing will simultaneously improve CEDI but negatively impact the TEDI

Although CEDI is a relatively novel metric to assess building performance, it is one that should not be overlooked as it has a notable impact on thermal comfort and will become more influential as the Toronto climate warms. When an energy model is developed for the project, the design team should consider additionally evaluating building performance using the predicted 2040 weather patterns.

Commissioning during and after construction

Even the best-designed buildings don't always perform as expected. Commissioning is a quality assurance process that helps convert design intent into actual building performance results. By using a combination of testing, verification, and documentation, the commissioning process can improve system and equipment operations, avoid unnecessary maintenance, and extend equipment service life, all while helping ensure the designed savings are realized. Best practice commissioning begins in the design phase and continues through construction and occupancy. Commissioning doesn't need to, nor should, end there; ongoing and re-commissioning can help identify many low and no cost measures to maintain or even boost building performance. Commissioning is one of the most cost-effective and low-risk strategies for reducing utility consumption, utility costs, and GHG emissions for both new and existing buildings

Building Management Systems and Services

To manage day to day operations of the building, a building management software (BMS) may be desirable. Many building operators do not know how best to optimize building performance, or if they are knowledgeable, may not have time to dedicate to fine tuning operations. Using a building management software can help to ensure maintenance schedules are maintained and send alerts if equipment is acting in unusual ways or out of design ranges, allowing the building to be proactive rather than reactive to equipment operations and tenant concerns.

Metering

Metering can be a valuable tool in analyzing building energy usage trends and encouraging tenant conservation. When creating a metering plan, it is important to be mindful of the desired outcomes.

Building level utility meters allow buildings to benchmark their performance. While commissioning and monitoring can help with ensuring a building performs as intended, energy benchmarking allows comparison

to similar buildings to see where performance is falling short. It can also allow comparisons between buildings within a portfolio.

While electric sub-meters are required in new residential units by law, using electrical meters in non-residential spaces as well as thermal, hot water, and cold water sub-meters can also be included for tenants. When tenants are directly responsible for and aware of their consumption, they are much more likely to take conservation efforts. This can have an added benefit to building operators as well through distributing utility costs to tenants leading to reduced common area fees. When developing a metering plan, it should be noted that revenue meters can be used for measurement and verification as well as revenue and vice versa.

Sub-meters can also be used throughout the building to help set utility rates for sub-metering, monitor operating efficiencies, identify atypical consumption, identify retrofit opportunities and to verify the impact of retrofits. If sub-meters are used for cost recovery, whole-building bulk bills are typically paid for by the condominium corporation and are recovered by charging the tenant directly or through a third-party sub-metering company where feasible. Certain services are sometimes blended into condo fees based on a ratio-utility billing system (RUBS), often allocating amenity costs based on square footage. While RUBS is a suitable method for allocating fees based on shared amenities and maintenance, it is not recommended for utilities. With RUBS there is no financial incentive for tenants to conserve energy and is not fully accurate which may result in significant over and under-estimating of consumption.

Some complications can arise with sub-metering. Due to the complex nature of load sharing, it can be difficult to accurately measure thermal energy use in a heat pump building. When using thermal meters, a greater temperature differential allows for improved accuracy, thus if a low-temperature system is used, this decrease in accuracy should be considered. To avoid any issues, all central equipment should be thermally metered to account for all thermal energy injected/rejected into the building loops. Meters should also be monitored on an ongoing basis. While metering technology is constantly improving, they can still fail and the quicker issues are resolved, the smaller the data loss will be.

3. PROJECT SPECIFIC ENERGY OPPORTUNITIES

3.1 GEOTHERMAL + OTHER LOW CARBON OPPORTUNITIES

While a description of low-carbon systems has been provided in Section 2.5, not all of these design solutions will be appropriate for the 2634, 2636, 2640, 2642 and 2654 Eglinton Avenue West and 1856 and 1856A Keele Street development. There are a few different options to explore when considering geothermal and these paths have differing financial implications, primarily directly financing the entire design and construction or partnering with a third party supplier.

With a third party, some contracts may have both the developer and geo supplier have investment/shared ownership interest in the system which would allow the developer to have a share in cash flow. Having a third party supplier come on board to design, build, finance, and operate the field can be advantageous as it reduces the upfront building costs to the developer, and ensures the asset will be properly managed over the lifetime of the contract. The geothermal supplier will make back their invested money into the geothermal infrastructure by charging the building tenants a service fee as part of their utility costs.

The project team will be connected to a third-party supplier for initial discussions on design opportunities. In addition, as the development is proposing a total gross floor area of 100,000 square metres or more, it is

additionally required to evaluate development of an on-site thermal network (district energy system). The outcomes of this discussion will be provided as a supplementary submittal to the City.

Energy Conservation & Demand Reduction

With the constant stream of development within the City of Toronto, the electricity grid is becoming increasingly stressed. The electricity distribution infrastructure is already constrained in the areas anticipating the most growth, and an estimated 22% increase in electricity demand due to projects currently in approvals will pose additional challenges. Furthermore, cooling demand for buildings will increase with rising temperatures, which means that the 22% estimated increase is conservative. Broader electrification from sources such as electric cars will further increase electrical demand. The IESO has estimated the increase in peak demand shown in Figure 11 which suggests the current grid capacity will not meet future demands.

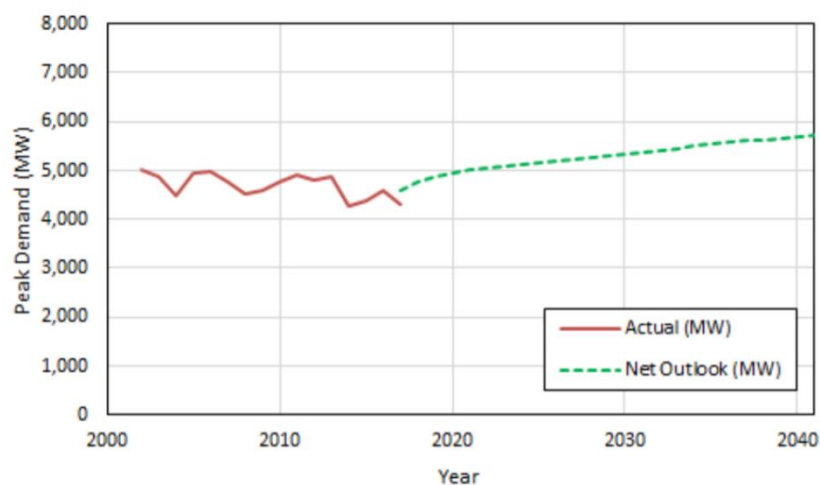

Figure 11 – Aggregated actual demand and net outlook by year²⁹

With increasingly strict carbon targets, building designs will be encouraged towards electrification of heating and hot water systems, which will likely further strain the electrical grid. Consequently, energy conservation and peak demand reduction in buildings is becoming increasingly important to ensure a resilient, stable grid in the future. Some advanced strategies to reduce grid demand and energy consumption include:

- Solar photovoltaics combined with battery storage
- Local energy generation
- Connecting to district energy systems
- Heat recovery from sewage infrastructure
- Large-scale geothermal systems

If the project were to pursue partial or full electrification in order to meet the TGS targets, the electrical service distribution provided would need to increase. This could cost in excess of \$500 per suite.

²⁹ Retrieved from: IESO Integrated Regional Resource Plan, August 9, 2019

The design team has been connected to Toronto Hydro to begin conversations on electrical distribution opportunities for the 2634, 2636, 2640, 2642 and 2654 Eglinton Avenue West and 1856 and 1856A Keele Street development.

3.2 FUTURE RETROFIT STRATEGIES

The City of Toronto recently accelerated their Climate Strategy³⁰ to achieve net-zero emissions by 2040. At the current stage of design, the project team is not intending to pursue a net-zero emissions design. As such, the building may need to retrofit to a net-zero design during its lifetime. Future-proof design elements have been discussed earlier in this report which, if implemented, will aid de-carbonization through retrofits.

As part of the City’s Climate Strategy, a *Net Zero Existing Buildings Strategy*³¹ has been released. It outlines a number of scenarios for building retrofits to assess what will be required to achieve the 2040 target. Figure 12 demonstrates the carbon reduction strategies explored in the study. Using ‘like-for-similar’ (LFS below) strategies do result in notable carbon savings, but are not sufficient to reach the net-zero target. Fuel switching (FS below) makes significant contributions to carbon savings, but alone also does not meet the net-zero targets. Each of the scenarios that did meet the net-zero targets required a more holistic approach that improved all aspects of the building design.

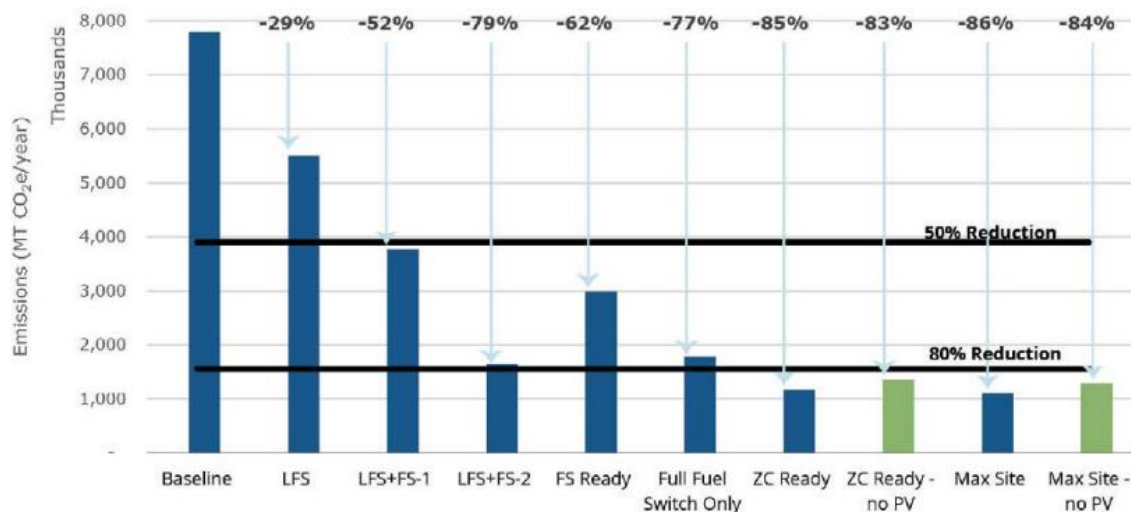

LFS – Like for Similar - Represents not just a simple replacement with same, but with a better level of performance (ex. double glazed windows with triple glazing)

FS – Fuel Switch – Level 1 represents a reasonable effort of fuel switch for buildings where financial or space limitations limit fuel switching opportunities (an example may be swapping natural gas boilers for electric boilers). Level 2 may not be feasible for all projects and represents best-in-class HVAC retrofits.

PV – Photovoltaics – On-site renewable energy generation with solar.

³⁰ <https://www.toronto.ca/news/net-zero-by-2040-city-council-adopts-ambitious-climate-strategy/>

³¹ <https://www.toronto.ca/wp-content/uploads/2021/10/907c-Net-Zero-Existing-Buildings-Strategy-2021.pdf>

ZC Ready – Zero Carbon Ready – Represents a project that achieves a minimum 80% reduction in carbon emissions and a complete or near-complete fuel switch to electricity or other low-carbon fuel source.

Figure 12 - Citywide Emissions Reduction Packages

Based on the CaGBC study *Decarbonizing Canada's Large Buildings: A Path Forward*³², retrofitting existing buildings to achieve net zero can be cost effective across a number of archetypes and vintages, including MURBs and offices. The analysis was performed over a 40-year timeline and is based on currently available technologies. With technological advances over time, it is likely that the business case for retrofits will improve over time.

When exploring retrofit opportunities, measures that reduce energy loads (envelope, lighting, and plug load improvements) will ideally be done prior to HVAC system upgrades. Prioritizing envelope upgrades will reduce building loads allowing for reduced equipment sizes for later mechanical retrofits.

An example of this might be replacing natural gas boilers with electric boilers. While doing a simple fuel switch can lead to significant carbon savings, electric boilers are only minimally more efficient than natural gas boilers. Performing envelope upgrades first would reduce boiler sizing and reduce the electrical supply requirements which may save significant capital costs. While carbon reductions have the greatest impact on the environment today, efforts should also be made to reduce total energy consumption where possible to protect against future changes in utility carbon intensities and costs.

Incorporating a full building retrofit to net-zero emissions at one time would typically be expensive and difficult to do while the building is occupied. A better strategy is to time retrofits with end-of-life with equipment.

Envelope upgrades may only occur once in a building lifetime, but significant load reductions can be achieved. Likely upgrades to consider are triple glazing with thermally broken frames, replacement of window wall systems, addition of significant rigid insulation attached with thermally broken clips, and additional roof insulation. When performing these retrofits, special consideration should be made to avoid risk of condensation and avoid overheating.

Electrification of space heating and water systems will have the greatest impact on carbon reductions, with high efficiency systems preferred. Heating and cooling plants of existing projects can be retrofitted to accommodate air source heat pumps or connect into a future district energy system. If there is room on site to accommodate borefield drilling, ground source heat pumps could be added at the basement level of the building to meet a portion of the peak demand capacity. While they have higher capital costs, they have a much higher efficiency than air source solutions. If upgrades are able to use existing ductwork and piping with retrofits focused on plant and air handlers, significant capital cost savings might be achieved.

Project teams should review both the City of Toronto and CaGBC studies for additional guidance on retrofit strategies.

³² https://www.cagbc.org/wp-content/uploads/2022/04/Decarbonizing-Canadas-Large-Buildings-Report-w.-Appendices-Final-Revised-Copy_with-formtting_2022-04-25.pdf

4. RENEWABLES

4.1 SOLAR PV

Solar PV is rapidly becoming an economically viable strategy for energy generation at the individual building level, thanks to the price reductions in solar panels over the last several years. As such, it is an important design consideration of low carbon and net zero buildings. Several developments of all types, including residential, institutional, and commercial have already incorporated PV into their designs or retrofitted existing buildings to take advantage of their long term economic benefits.

There are two predominant types of solar PV technologies in the market today; rooftop and building-integrated PV. In the current market, rooftop PV is likely most feasible to integrate into the development. Given the approximate total roof area of the development, it is estimated that at most **284 m²** may be available for solar energy production considering shading, minimum outdoor amenity areas, and mechanical requirements, resulting in the following levels of production in Table 9. Toronto’s green roof by-law provides exemptions to green roof area for roof area dedicated to solar PV.

Table 9 - Predicted Solar PV Production Potential

System Size (kW)	50
System Size (m ²)	280
Annual production (kWh)	57,500
% of energy requirement (Scenario 1)	1.9 %
% of energy requirement (Scenario 3)	2.9 %

Effective rooftop solar PV installations require access to adequate sunlight as well as the space needed to house the panels. This creates constraints for high-rise buildings, like 2634, 2636, 2640, 2642 and 2654 Eglinton Avenue West and 1856 and 1856A Keele Street, which are typified by a small roof area relative to total conditioned area. Given this, on-site solar PV will not be a viable solution to see significant reductions in energy use or to offset a near zero emissions development. If the 2634, 2636, 2640, 2642 and 2654 Eglinton Avenue West and 1856 and 1856A Keele Street development were to achieve the highest performance levels of the Toronto

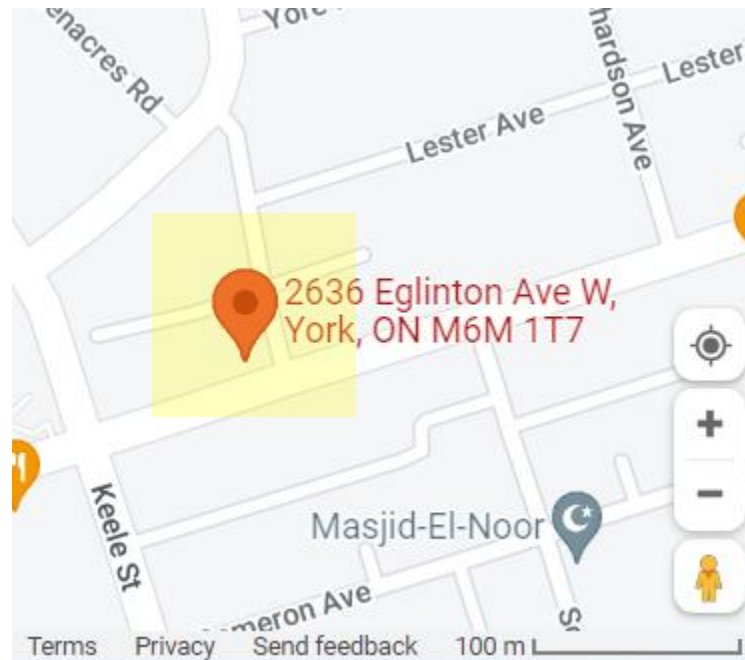

Green Standard, a minimum of **9,551m²** of rooftop solar PV area would be required.

Figure 13 – Rooftop Solar PV Area Required to Offset Highest Performance Energy

Building integrated PV (BIPV) can be integrated into a number of envelope components including skylights, cladding, shading structures, and balcony railings. BIPV technology has made advances in both efficiency and appearance and is a viable way for architects to create a beautiful building while reducing energy consumption. One of the advantages of BIPV is the significant increase in potential area on a building compared to rooftop PV. Estimating production potential can be more complex with BIPV than with rooftop solar as there are a number of potential approaches and a more complex shading risk from adjacent buildings or envelope conditions (such as balconies).

4.2 RENEWABLE ENERGY CERTIFICATES + CARBON OFFSETS

Achieving net-zero design on-site can be difficult to achieve, leading a number of projects to purchase renewable energy certificates (RECs) or carbon offsets. While RECs and carbon offsets are sometimes both referred to as offsets, they are actually quite different.

Offsets are based on the carbon content of energy use and can be used for both natural gas and electricity consumption. RECs are only used for electricity and represent the production of renewable electricity. Both are beneficial and have their place, and should be used as appropriate to achieve each project’s goals. As the carbon content of the electric grid in Ontario is low, offsets are typically a more affordable option in the local market.

Table 10iii - Basic Differences between Offsets and Recs³³

	Offsets	RECs
Unit of Measure	Metric tons of CO ₂ or CO ₂ e	Megawatt hours (MWh)
Source	Projects that avoid or reduce greenhouse gas emissions to the atmosphere – may include methane abatement, reforestation, etc.	Renewable electricity generation
Purpose	Represents a reduction in GHG emissions, support for emissions reduction activities, and to lower the costs of GHG emissions mitigation.	Convey use of renewable electricity generation; underlie renewable electricity claims, expand consumers’ electricity service choices, and support renewable electricity development.
Consumer Environmental Claims	Can claim to have reduced or avoided GHG emissions outside the organization’s operations.	Can claim to use renewable electricity from a low or zero emissions source.

³³ Simplified from https://www.epa.gov/sites/default/files/2018-03/documents/gpp_guide_recs_offsets.pdf

RECs and carbon offsets are ideally purchased locally (within the province of Ontario) and should come from a certified provider. The CaGBC Zero Carbon Building Standard (ZCB)³⁴ suggests pursuing offsets with one of the following criteria:

- Green-e Climate certification or equivalent
- Certified under one of the following high-quality international programs:
 - o Gold Standard
 - o Verified Carbon Standard (VCS)
 - o The Climate Action Reserve
 - o American Carbon Registry

When purchasing RECs and offsets, projects should also strive to ensure they are high quality. The ZCB suggests that projects ensure that the purchased emissions reductions will not be cancelled over time or result in increased emissions elsewhere.

With the current project target of v4 Tier 1, the 2634, 2636, 2640, 2642 and 2654 Eglinton Avenue West and 1856 and 1856A Keele Street development would need to offset an estimated 252,931 kg of carbon to achieve net-zero. While costing for RECs and offsets vary from project to project, EQ estimates that to fully offset building consumption would cost between **\$1,700-\$16,900** annually³⁵.

Table 11: Estimated Annual Cost of Green Power³⁶

	Scenario 1	Scenario 2	Scenario 3
Annual Cost of Carbon Offsets ³⁷	\$1,700	\$1,100	\$400
Annual Cost of RECs + Offsets	\$16,900	\$18,600	\$17,500
Carbon offsets	\$6.63 per Ton CO ₂ e		
RECs	\$8.81 per MWh		

³⁴ https://portal.cagbc.org/cagbcdocs/zerocarbon/v2/CaGBC_Zero_Carbon_Building_Standard_v2_Performance.pdf

³⁵ Uncertainty in carbon content of the electrical grid will impact the price of carbon offsets. The grid is expected to have a higher carbon content in Ontario in the future as load previously met by some nuclear plants will have to be met by natural gas generators.

³⁶ Averaged rate based on recent quotes prepared for EQ - \$6.63 per Ton CO₂

³⁷ Based on an average Carbon Offsets cost of \$5.3/Ton CO₂e

5. EMBODIED CARBON

While energy efficiency of buildings has improved and operational carbon has decreased, the relative importance of embodied carbon has increased. Embodied carbon refers to the greenhouse gas emissions arising from the manufacturing, transportation, installation, maintenance and disposal of building materials. Conducting a material emissions assessment of the building can be used as a tool to calculate the embodied carbon in current building design and identify low carbon strategies. Embodied carbon is a significant percentage of global emissions and requires urgent action to address it.

There are numerous strategies that can be used to reduce embodied carbon in a building, many of which can be accomplished for no additional cost and minimal performance impacts. The intention of this analysis is to better understand these strategies and provide a project specific carbon impact benchmark at an early design stage.

As per Figure 14 and 15 below, the proportion of embodied carbon in this analysis is consistent through the lifetime of the building, while the operational carbon gradually increases as the demands of the building increase. As the embodied carbon represents a bulk of the lifetime carbon emissions, the embodied carbon assessment reviews opportunities to benchmark and reduce carbon between upfront carbon to end of life carbon.

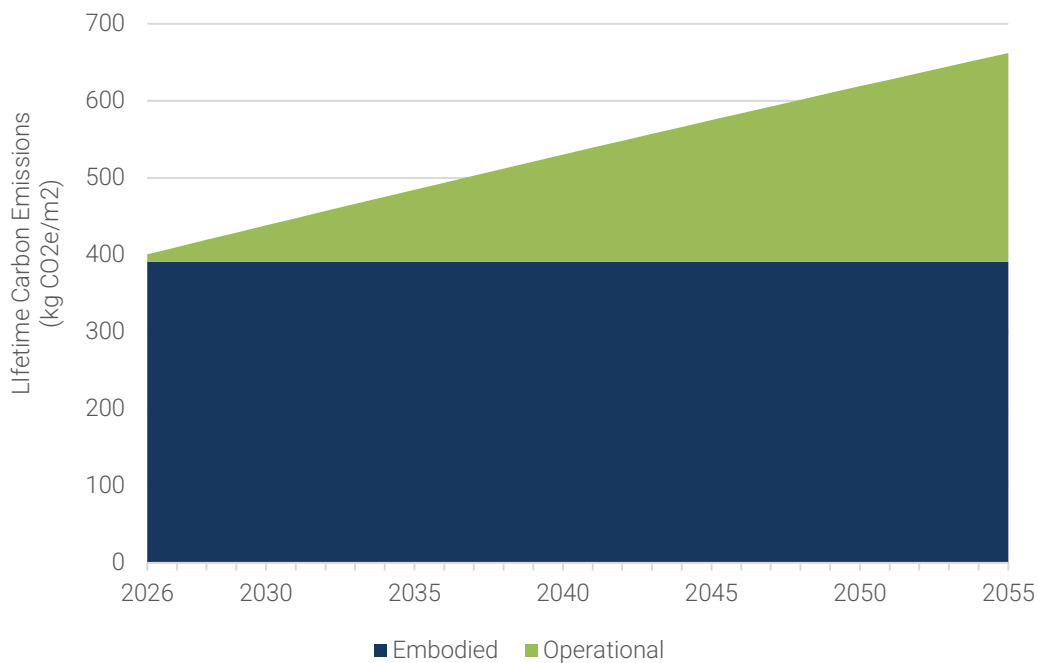

Figure 14 - Embodied versus Operational Carbon

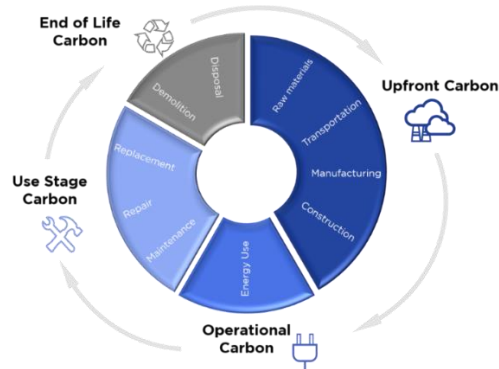

Figure 15 - The Carbon Cycle

5.1 SYSTEM BOUNDARY

The system boundary defines which life cycle activities are included in the embodied carbon analysis. The system boundary of this embodied carbon assessment follows life cycle stages identified in EN 15978³⁸. The below figure identifies all life cycle stages in the embodied carbon lifecycle equation. The system boundary of this assessment is A1 to A5. A1 to A5 identifies the upfront carbon portion of the full embodied carbon emissions equation. Upfront carbon is emitted before a building is in operation and significantly outweighs operational carbon.

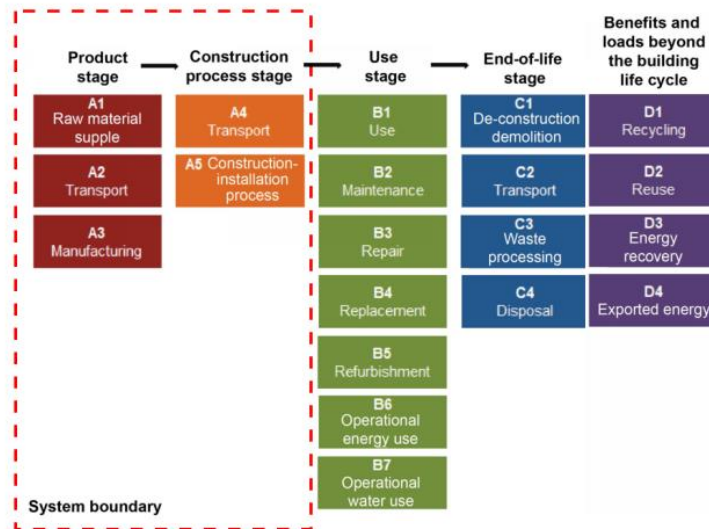

Figure 16 – Required Inclusions for Carbon Analysis at Rezoning

³⁸ https://www.greenbooklive.com/filelibrary/EN_15804/PN326-BRE-EN-15978-Methodology.pdf

5.3 GENERAL PROJECT INFORMATION

The following is a list of the software used, relevant general project information and building components analyzed.

Table 12 – Analysis Statistics

Software	One Click LCA Materials Selection
Project Life	60 year
Assessment Timing	Schematic Design
Total Construction Area (m ²) excluding existing components	34,775
Components Analyzed	<p><u>Foundation/Substructure</u></p> <ul style="list-style-type: none"> • Foundation • Columns • Slabs • Structural Wall • Wall • Enclosure <p><u>Above Grade Structure</u></p> <ul style="list-style-type: none"> • Columns • Beams • Slabs • Structural walls <p><u>Envelope</u></p> <ul style="list-style-type: none"> • Opaque wall • Insulation • Windows • Roof Assembly

5.5 CARBON RESULTS AT UPFRONT CARBON STAGE

A summary of the breakdown of the life cycle stage breakdown of the building from A1-A5. Based on the construction area listed above, the baseline carbon emissions from current design with 391 CO₂e/m², for the upfront carbon life cycle stage. This is representative of the new construction portion of the development.

Table 13 – Preliminary Results by Stage

Life-cycle Stage				Carbon Emissions from Materials (kg CO ₂ e)
Upfront	Product	A1	Raw Material Supply	11,175,009
		A2	Transport (to factory)	
		A3	Manufacturing	
	Construction	A4	Transport (to site)	1,813,704
		A5	Construction & Installation	605,685
Total Upfront Carbon				13,594,399

82% of the carbon is attributed to raw material supply, transport to factory and manufacturing of the product stage. The remaining 18% of carbon is attributed to transport to site and construction & installation during construction stage, as can be seen in Figure 17. The vast majority of emissions are included in the A1-A3 product life stage, with approximately over 80% of embodied carbon captured within upfront carbon (A1-A5). Therefore, the best way to reduce embodied carbon is to address the production of materials required for the development.

■ A1-A3 Product Stage ■ A4-A5 Construction Stage

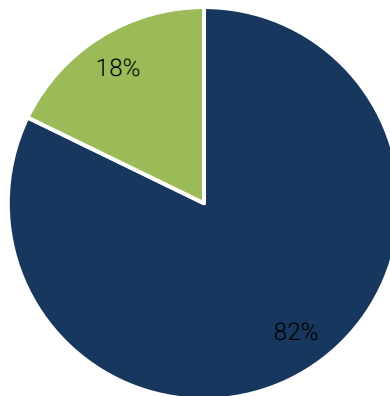

Figure 17 – Life Cycle Stage Breakdown of Carbon Emissions in kg CO₂e

5.6 CONTRIBUTION ANALYSIS

As discussed previously, the most significant portion of embodied carbon emissions are in the upfront carbon emissions of material extraction, product and manufacturing. Table 14 a summary of top carbon emission assemblies’ contributors within the building, and applicable material components.

Table 14 - Contribution Analysis

Building Assemblies/Materials	Carbon Emissions (kg CO ₂ e)
Beams and Columns	1,402,677
Floors and Slabs	2,589,547
Foundations	503,079
Roofs	199,368
Walls	4,287,626

5.7 REDUCTION MEASURES CONSIDERED

In order to reduce the amount of carbon in the building, below are some targeted measures that can achieve reductions anywhere between 7% to 22% of total building carbon.

Lower Carbon Concrete (GUL and 30-40% SCM)

A key component to reducing the carbon impact in a concrete structure building is reducing the carbon impact of concrete. Two ways of doing this are increasing the supplementary cementitious materials (SCM) and limestone components.

Supplementary cementitious materials are natural or industrial byproducts that exhibit cementitious behaviours when included in the mix. In particular, fly ash is a type of SCM that can be used to replace portions of Portland cement. The benefit to using an SCM is its lower carbon factor compared to traditional Portland cement. The environmental product declaration for Canadian general use ready mix concrete published in January 6, 2017 states that an average 30MPA ready mix concrete product with 15-29% fly ash versus 30-40% fly ash without air entrained has a 12% reduction in product stage carbon.³⁹

General use cement (GU), also known as Portland cement is the ingredient typically used for binding in concrete mixes. Approved by the CSA standard A3001-08, up to 15% of limestone to cement can be incorporated producing what is known as general use limestone cement (GUL), also known as Portland limestone cement⁴⁰. Incorporating limestone reduces the amount of Portland cement in the mix, and can contribute approximately 8% to the carbon reduction of a building.

The total carbon reduction for this project for both measures is together would reduce the carbon impact of the project by roughly 15%.

³⁹

<https://static1.squarespace.com/static/586aea28b3db2bc4426405/t/59089fb517bffc913c625a92/1493737421917/CRMCA+EPD+20170317.pdf>

⁴⁰ <https://www.cement.org/docs/default-source/cement-concrete-basics-pdfs/csa3000e-ct041-new-canadian-standard.pdf>

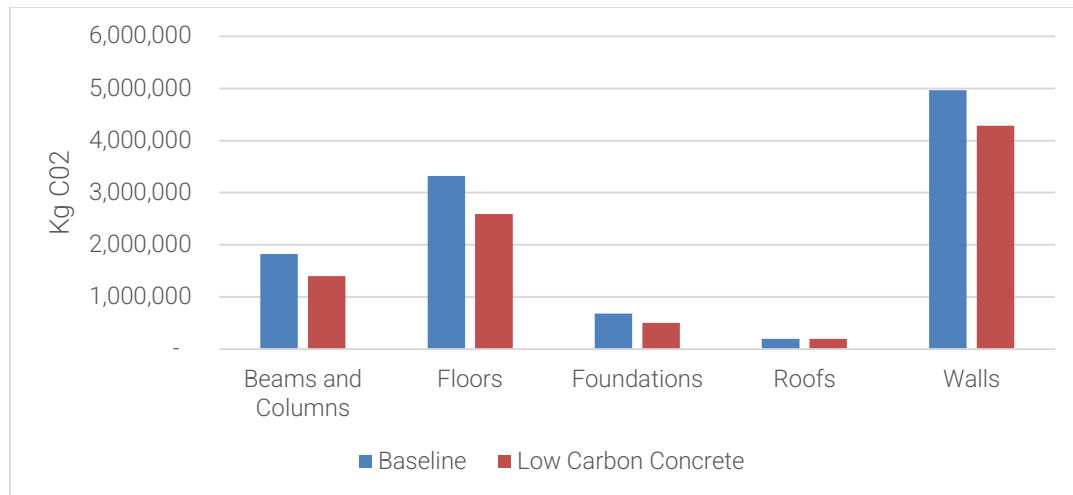

Figure 18 – Low Carbon Concrete – 30-40% SCM and GUL

Prolonged Shear Wall Cure Time

Certain building components such as shear walls, slab on grade and stairs may be able to tolerate a longer cure time than 28 days in the construction schedule. For relevant components for this design, a 56-91 cure time can be considered to reach full strength. Best practice would be to advise the concrete supplier at the tendering process of potential components that can accept a longer cure time without a delay in the construction schedule, and the supplier can advise if they have products to support the requirement. In comparison to Canadian industry standard general use concrete, 40MPA @ 56 day cure time is approximately a 50% carbon reduction.⁴¹ This is due to the reduced amount of cement added to the mix, resulting in a longer cure time. Compared to the baseline design, using a 56 day cure time mix for shear walls results in a 10% reduction in total building carbon.

Less Carbon Intensive XPS Insulation

Where applicable in the assembly, considering substituting to an XPS insulation with low carbon intensity. For the purpose of this assessment, an industry leading XPS was selected to replace exterior insulation in the envelope where applicable. The reported embodied Global Warming Potential (GWP) is 2.07, which is approximately half of the industry average. Compared to the typical XPS used, lower impact XPS could result in a 1% reduction in total building carbon. Due to its nature, XPS Insulation is a passive product requiring no utilities or maintenance over its useful life. Nevertheless, provided the XPS foam is used as intended, during the use phase, reductions in a building’s energy consumption and releases of blowing agents do occur. Although both of these can be attributed to the use of XPS foam insulation, only the environmental impacts due to the blowing agent emissions have been included within the system boundaries since diffusion of the blowing agent occurs whether or not the XPS foam is used for thermal insulation to affect these subsequent energy savings.

⁴¹ Lafarge Environmental Product Declaration Ready Mix Concrete Mix Name: RMPS255511X

5.8 RESULTS SUMMARY

A summary of building carbon baseline results and potentials for GWP reduction in the scope of A1-A3 are summarized below.

Table 15 – Embodied Carbon Reduction Summary Chart

Description of Embodied Carbon Reduction Measure	Building Carbon (kg CO ₂ e/m ²)	GWP Reduction %
Baseline	391	
Low Carbon Concrete	332	15%
Longer cure time for Shear Walls	351	10%
Less carbon intensive XPS Insulation	387	1%

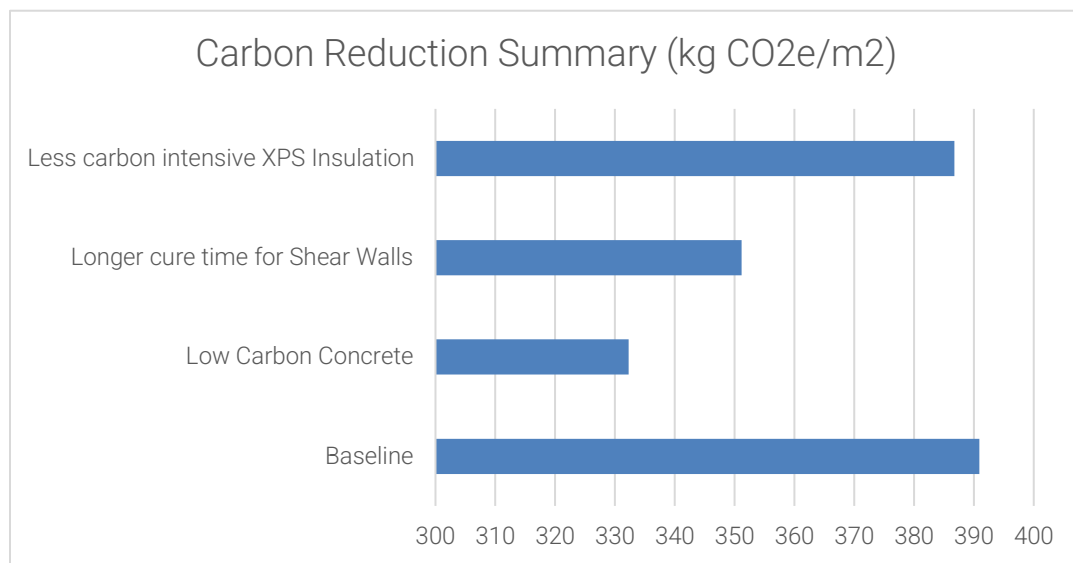

Figure 19– Embodied Carbon Reduction Summary Graph

6. FINANCIAL INCENTIVES

Development Charge Refund

Projects that are pursuing higher Tiers of TGS are eligible to receive a partial refund of development charges. The potential refund for this project, based on stats dated October 28, 2022, is shown in Table 16.

Table 16 - City of Toronto Development Charge Refund TGS Tier 2 & 3 Cap - Effective August 23, 2022⁴²

Category	Tier 2 Amount	Tier 3 Amount	Project Count ⁴³
Residential			
Apartment – two bedroom and larger	\$4,403.00	\$5,283.60	191
Apartment – one bedroom and bachelor	\$3,003.18	\$3,603.81	179
Non-Residential use (per square meter ground floor area)	\$50.91	\$61.10	324
Maximum Estimated Development Charge Refund – TIER 2			\$ 1,395,037
Maximum Estimated Development Charge Refund – TIER 3			\$ 1,674,046

Sustainable Energy Plan Financing

The City of Toronto operated a Sustainable Energy Plan Financing⁴⁴ program that makes loans available to eligible projects at rates equal to the City's cost of borrowing. This financing can support engineering studies, equipment and installation costs, commissioning, and metering purchases or service fees.

Savings by Design

The Savings by Design⁴⁵ program by Enbridge is available to projects greater than 50,000 sq.ft. and offers a financial incentive of up to \$15,000 for a 20% improvement in energy performance over the building code and an additional \$15,000 for building commissioning. A great feature of the Savings by Design program is a mandatory IDP workshop featuring the design team and industry experts – a value of up to \$35,000.

Canada Infrastructure Bank (CIB) Incentives

The CIB offers a range of incentives via offering long-term, below market interest rates to projects which focus on deep energy and GHG emission savings. The incentives are part of the CIB's \$10 Billion Growth Plan, aiming to strengthen the Canadian economy and stimulate job creation through infrastructure investments.

The CIB's Commercial Buildings Retrofit Incentive (CBRI) provides financing for large scale retrofits which decarbonize existing privately owned commercial buildings. Applicants become eligible with a minimum investment of \$25 million and a minimum carbon savings of 30% across a portfolio (with a minimum 25% carbon or energy savings for each individual building).

The CIB also offers incentives to projects which focus on Clean Power, for example through low carbon district energy systems with a particular focus on reducing GHG emissions.

CMHC MLI Select

In Spring 2022, CMHC launched their MLI Select program, which provides insurance incentives based on a point based system related to affordability, accessibility and energy efficiency. Projects which demonstrate increasing levels of energy efficiency and GHG reductions will achieve higher scores and become eligible for increasingly flexible financing options, and lower premiums. Options are available for both new construction

⁴² toronto.ca/wp-content/uploads/2022/08/967a-Tier-2-Caps-Effective-August-15-2022.pdf

⁴³ Suite type breakdown based on estimates provided by design team

⁴⁴ <https://www.toronto.ca/legdocs/mmis/2018/pe/bgrd/backgroundfile-117766.pdf>

⁴⁵ http://www.savingsbydesign.ca/commercial/download/2020-Savings-by-Design_v7.pdf

projects demonstrating energy and GHG reductions over the NECB 2017 energy code, as well as existing buildings demonstrating energy and GHG reductions over current performance.

7. PREFERRED SCENARIO AND RECOMMENDATIONS

7.1 OPERATIONAL PERFORMANCE

Based on discussions with the client team, the 2634, 2636, 2640, 2642 and 2654 Eglinton Avenue West and 1856 and 1856A Keele Street development will achieve the version 4 Tier 1 targets. This performance will change over the life of the building as the climate warms. A summary of the building targets as well as projected 2050 performance is summarized in Figure 20.

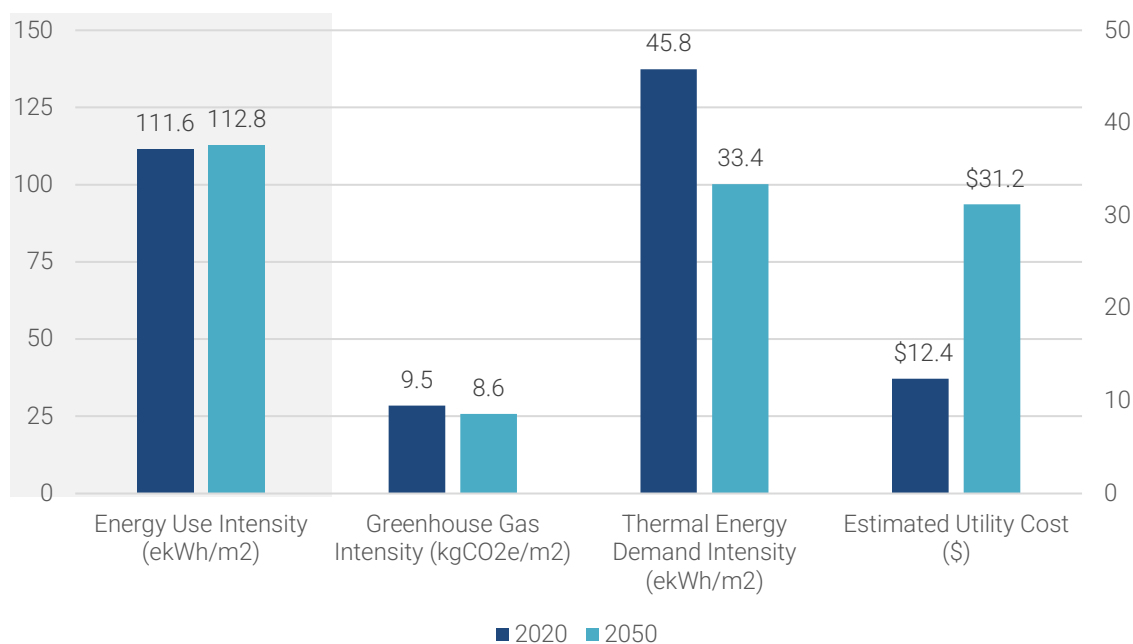

Figure 20 - 2020 and 2050 Targeted Performance

As the climate warms, heating loads will decrease and cooling loads will increase. With the current design intent, this would lead to reduced natural gas use and increased electrical consumption. This can be most clearly seen through the decrease in operational carbon and increase in utility costs over time. Additional costing information can be found later in this section of the report which details escalation rates and carbon pricing that has been included in the estimate.

7.2 LIFECYCLE CARBON ASSESSMENT

We recommend pursuing any or all of the three options for embodied carbon reduction outlined in Table 17. Many of these changes can be reviewed with the contractors or material suppliers at the tendering process and where costing adjustments can be made accordingly. Best practice is to engaged consultants, suppliers, and contractors as early as possible in the decarbonization process to identify possibilities for reduction.

Table 17 - Embodied Carbon Reduction Summary

Description of Embodied Carbon Reduction Measure	Building Carbon (kg CO ₂ e/m ²)	GWP Reduction %
Baseline	391	
Low Carbon Concrete	332	15%
Longer cure time for Shear Walls	351	10%
Less carbon intensive XPS Insulation	387	1%

7.3 COST PREMIUMS

While some of the design decisions required to meet the TGS targets may result in direct increased costs (such as triple glazing), others like EnergySTAR appliances or low flow plumbing fixtures are often considered cost neutral. Investing costs into upgrading the building envelope can reduce loads enough that mechanical equipment could be downsized, saving upfront capital costs.

Based on previous project work, EQ has prepared a preliminary cost estimate for the project in comparison to a traditional standard design (assumed equivalent to TGS v3 Tier 1). Table 18 shows the estimated cost premium. The costs indicated below are preliminary in nature and should be evaluated independently as part of a full feasibility study by the design team.

Table 18 - Estimated Capital Cost Premiums

	Cost Premium / Unit – Increase over v3 Tier 1	Project Estimated Premium
Overall construction cost	TBD	TBD
Major Contributors		
Improved opaque wall	\$30 /m ²	\$272,000
Geothermal System	TBD	TBD
Electrical service increase due to partial electrification	\$120 /suite	\$45,000

7.4 UTILITY COSTS

Electricity prices in Ontario are currently almost five times higher than natural gas⁴⁶. This encourages building owners to target electricity savings in order to minimize operating costs. When comparing to carbon emissions however, the opposite trend is seen with natural gas having more than six times the carbon

⁴⁶ Based on 2022 estimates of \$36.11/GJ [\$0.13/kWh] vs. \$7.37/GJ [\$0.28 /m³] for electricity and natural gas respectively, inclusive of the current Carbon tax.

intensity than electricity⁴⁷. In order to meet increasingly rigorous carbon targets, a shift away from natural gas and towards electricity will inevitably be required. Depending on how the TGS targets are met, this will likely lead to relatively minor cost reductions when compared to the deep energy and carbon savings achieved.

To understand the utility costs associated with the project over its life, EQ has performed a 30-year utility cost estimate. To perform this work, the assumptions listed in Table 19 have been used.

Table 19 - Cost Projection Estimates

	Escalation Rate
Consumer Price Index	2%
Electricity	3%
Natural Gas	3%
Carbon	10-30% annually through 2030 based on latest Liberal plan to hit \$170/ton by 2030 ⁴⁸ ; aligned with CPI thereafter
Assumed 30 Year Period	2026 - 2055
Climate Assumptions	Toronto CWEC 2020 ⁴⁹ – 2026 weather Toronto 2050 ⁵⁰ – 2055 weather Assumed linear scaling over the 30 year period

The estimates in this report are based on modelled performance and will differ from actual utility costs once the building is in operation. Typical weather files, standard occupant behavior assumptions, and the model assuming perfect building operation lead to these estimates, showing an idealized performance. It is also worth noting that the comparison reflects the current utility rates and carbon emission factors and escalations available which may fluctuate over time, for example, with increasing carbon pricing or changes to the fuel supply mix of the electricity grid. Based on this analysis, the 2634, 2636, 2640, 2642 and 2654 Eglinton Avenue West and 1856 and 1856A Keele Street project annual energy costs will be approximately \$330,500 in 2020, escalating to \$829,600 in 2050, as shown in Figure 21.

⁴⁷ 50.22 kg CO₂e/GJ vs 8.33 kg CO₂e/GJ for natural gas and electricity respectively, based on Environmental and Climate Change Canada’s National Inventory Report (NIR)

⁴⁸ <https://www.canada.ca/en/environment-climate-change/services/climate-change/pricing-pollution-how-it-will-work/carbon-pollution-pricing-federal-benchmark-information/federal-benchmark-2023-2030.html>

⁴⁹ https://climate.weather.gc.ca/prods_servs/engineering_e.html

⁵⁰ <https://www.pacificclimate.org/data/weather-files>

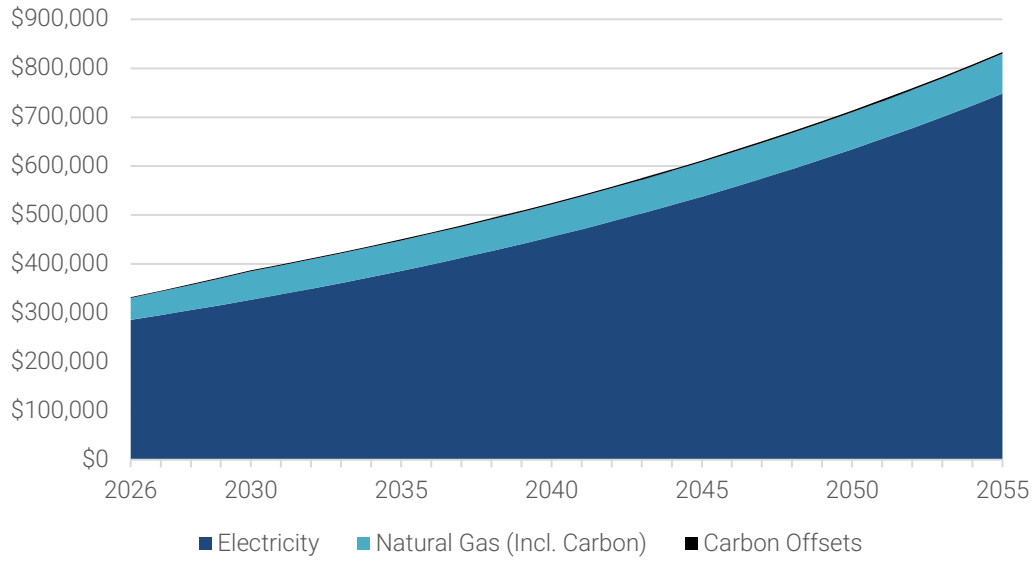

Figure 21 – 30 Year Utility Cost Projection – New Construction

It should be noted that this only considers one possible path to compliance. The energy model that will be developed for SPA can be a great tool to evaluate the impacts of design alternatives and explore how best to and utility cost savings.

8. CONCLUSIONS

The 2634, 2636, 2640, 2642 and 2654 Eglinton Avenue West and 1856 and 1856A Keele Street project preferred scenario is to achieve the minimum Toronto Green Standard version 4 Tier 1 requirements (Scenario 1). A summary of the estimated performance is in the table below.

Table 20 - Preferred Scenario Estimated Performance

	Estimated Performance (New Construction)
Energy Use Intensity	111.6 ekWh/m ²
Greenhouse Gas Intensity	9.5 kgCO ₂ e/m ²
Thermal Energy Demand Intensity	45.8 ekWh/m ²
Utility Cost	\$12.4 /m ²
Embodied Carbon	391 kgCO ₂ e/m ²
Cost Premium (over TGS v3 Tier 1)	TBD
Annual Carbon Offset to Achieve Net Zero	\$1,700

From preliminary analysis, some design considerations the project team might want to explore include:

- Improving the effective performance of the opaque building envelope
- Explore opportunities to reduce balcony perimeters and glazing areas
- Reducing domestic hot water natural gas consumption by using low flow fixtures
- Exploring options available to you for low carbon District Energy connections
- Exploring options to de-carbonize space and domestic hot water heating by electrification and heat pump technologies

As the project is not being designed to achieve net-zero carbon, efforts should be made to future proof the design to more easily accommodate future net-zero retrofits. Some aspects could include locating the mechanical plant at or below grade, or ensuring the roof structure will be able to support future air source heat pumps.

The project team is encouraged, though not required, to explore the feasibility of higher tiers of energy and carbon performance, as well as draw on the *Near Zero Emissions* building design strategies to create a truly sustainable development. The design alternatives, renewable energy, resilience, and advanced energy solutions discussed in this report are recommendations only, and the decision to incorporate them into the final design is up to the discretion of the project team. These measures have been included in this report at a high level and a detailed cost and feasibility analysis should be conducted prior to incorporation.

APPENDIX A – DETAILED EXPECTED ENERGY PERFORMANCE

By Phase / Block

2634, 2636, 2640, 2642, and 2654 Eglinton Avenue West and 1856 and 1856A Keele Street				
	Scenario 1	Scenario 2	Scenario 3	Existing
	v4 Tier 1	v4 Tier 2	v4 Tier 3	Existing
Gas Use (eMWh)	1,087	549	0	0
Gas Intensity (ekWh/m ²)	40.9	20.7	0.0	117.7
Electricity Use (MWh)	1,882	2,092	1,977	0
Electricity Intensity (ekWh/m ²)	70.7	78.6	74.3	100.3
Target Energy Intensity (ekWh/m ²)	135.0	100.0	75.0	-
Total Energy Intensity (ekWh/m²)	111.6	99.3	74.3	218.0
Total Energy (eMWh)	2,968	2,641	1,977	0
% Savings vs Tier 1	-	11%	33%	-
Target GHG intensity (kg CO ₂ e/m ²)	15.0	10.0	5.0	-
GHG intensity (kg CO₂e/m²)	9.5	6.1	2.2	24.3
Total GHGs (tonnes CO ₂ e)	253	162	59	0
% Savings vs Tier 1	-	36%	77%	-
Target Thermal Energy Demand Intensity (ekWh/m ²)	50.0	30.0	15.0	-
Thermal Energy Demand Intensity (ekWh/m²)	45.8	29.9	14.6	-
Total Thermal Demand (eMWh)	1,218	795	388	-
% Savings vs Tier 1	-	35%	68%	-

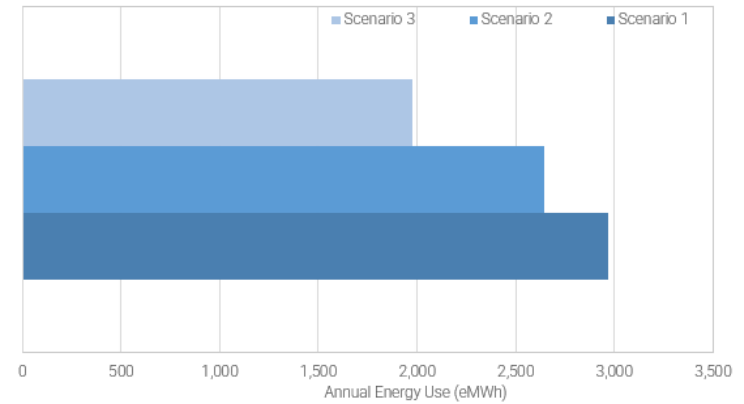

APPENDIX B – DESIGN GUIDANCE

Toronto Green Standard Performance Targets

Table 21 - TGS Targets Over Time

Multi-Family Residential Buildings		EUI kWh/m ²	GHGI kgCO ₂ /m ²	TEDI kWh/m ²
TGS v4 (2022)	Tier 1	135	15	50
	Tier 2	100	10	30
	Tier 3	75	5	15
TGS v5 (2025)	Tier 1	100	10	30
	Tier 2	75	5	15
TGS v6 (2028)	Tier 1	75	5	15

Sample Package Performance

	V4 Tier 1	V4 Tier 2	V4 Tier 3
EUI / GHGI / TEDI	111.6 / 9.5 / 45.8	99.3 / 6.1 / 29.9	74.3 / 2.2 / 14.6
Wall R-Value	R-5.5	R-8	R-15
Glazing Type / Performance	Double Glazed U-0.35 / SHGC 0.35	Triple Glazed U-0.20 / SHGC 0.35	Triple Glazed U-0.20 / SHGC 0.40
WWR	60%	50%	50%
Infiltration	Per Code	Per Code	25% Reduction
Suite Heat Recovery	65%	80%	80% In-Suite or connected to corridor unit
Corridor Ventilation	30 cfm/door	15 cfm/door	15 cfm/door
Corridor Heat Recovery	None	None	70%
Primary HVAC System Type	Geo-exchange Heat Pumps	Geo-exchange Heat Pumps	Geo-exchange Heat Pumps

	V4 Tier 1	V4 Tier 2	V4 Tier 3
EUI / GHGI / TEDI	111.6 / 9.5 / 45.8	99.3 / 6.1 / 29.9	74.3 / 2.2 / 14.6
Lighting	Per Code	Per Code	Per Code
Plumbing Fixtures	Low Flow	Low Flow	Enhanced Low Flow
DHW System	Condensing Natural Gas Boilers	Domestic Hot Water Heat Pump sized for 30% of peak load – COP 2.0	CO2 Heat Pump – COP 4.5 with electric backup
Sewage Heat Recovery	None	None	None

Resilience

Resilient design is the intentional design of buildings in response to vulnerabilities to disaster and disruption of normal life. In the long term, global warming is rapidly increasing temperatures and more extreme weather events. Designs will need to accommodate these changes over the lifetime of the building. In the short term, the goal should be to keep residents in place during extreme weather events by using passive design measures, backup power, and areas of refuge.

Climate Resiliency

In 2011, the City of Toronto produced, in collaboration with SENES Consulting, the Toronto Future Weather and Climate Driver Study. Within this report, it was shown that while the Toronto climate has already changed from climate zone 6 (Ottawa) to climate zone 5 (meaning that our climate is getting warmer), this trend is expected to continue with Toronto moving to climate zone 4 (Washington DC) by the year 2040.

Toronto's **Future Weather***

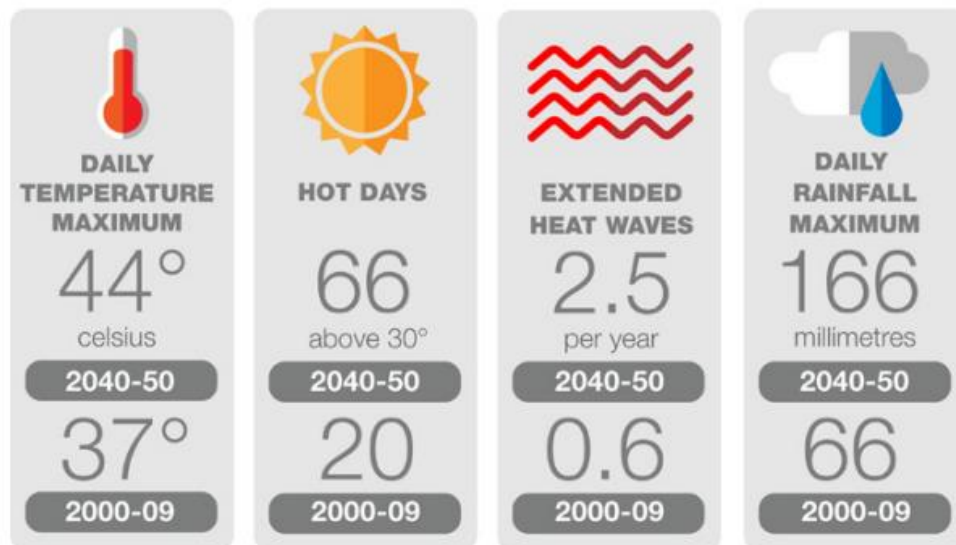

*Source: Toronto's Future Weather and Climate Driver Study, 2011

Figure 22 - Toronto Predicted Future Weather Patterns

This shift can lead to lower heating and higher cooling loads over the life of the building. Using up to date, or even predicted, weather data when doing early analysis can allow the design team to consider how the design will perform over the life of the building.

Resilient Design

While increasing back-up power capabilities can improve resiliency, passive design is vital to ensuring that occupants are able to stay in the building during a power outage. The better a building is able to maintain its temperature without mechanical conditioning, the longer people will be able to remain in place. Energy modelling can be used to estimate how a building's interior temperatures will respond to an extended power failure. The *Zero Emissions Building Framework* analyzed this impact for each TGS performance tier, for a high-rise residential building. The results are summarized in Figure 23 below and show a stark difference in maintained interior temperature between the various performance tiers⁵¹. Indoor temperatures are analyzed at 72 hours and 2 weeks following a power outage, and show that indoor temperature drop significantly in lower performance scenarios, while the near net zero performance maintains an indoor temperature of 18.3°C even after 2 weeks without power. While a two-week outage is likely an extreme, improved resilience will have a major effect on vulnerable populations

⁵¹[https://www.toronto.ca/311/knowledgebase/kb/docs/articles/municipal-licensing-and-standards/investigation-services/bylaw-enforcement-low-heat-no-heat-air-conditioning-air-conditioner-units-residential-properties.html#:~:text=Heating%20\(Minimum%20temperatures\),June%201%20of%20each%20year](https://www.toronto.ca/311/knowledgebase/kb/docs/articles/municipal-licensing-and-standards/investigation-services/bylaw-enforcement-low-heat-no-heat-air-conditioning-air-conditioner-units-residential-properties.html#:~:text=Heating%20(Minimum%20temperatures),June%201%20of%20each%20year)

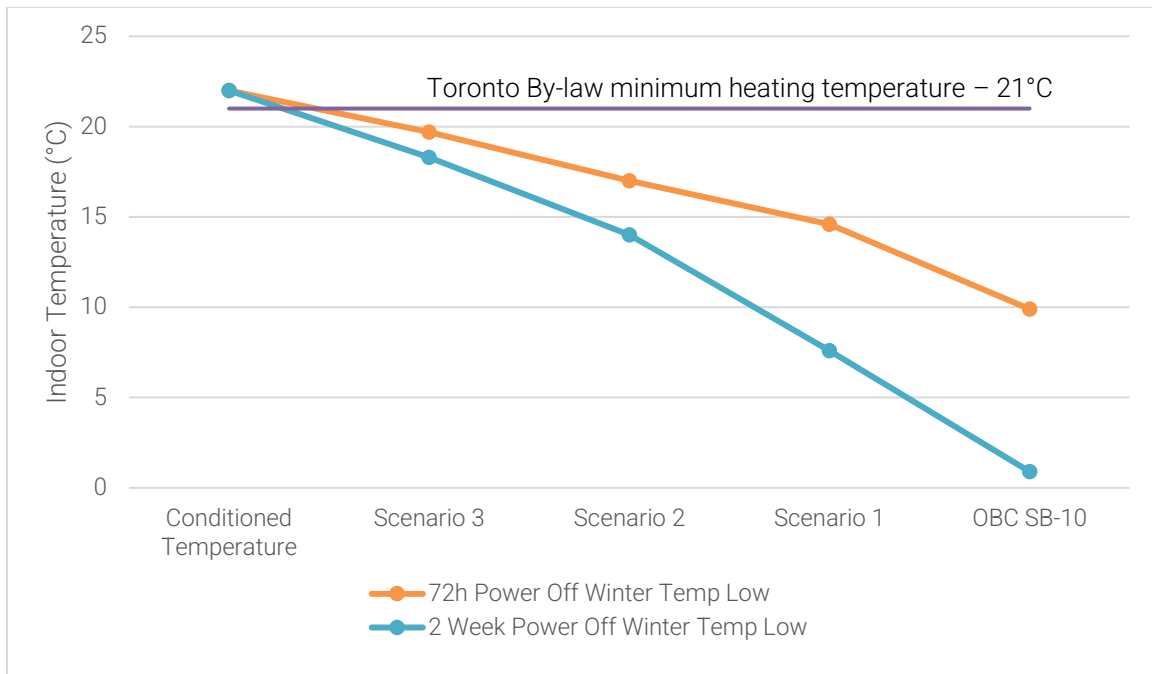

Figure 23 - Indoor Temperature in the Event of a Power Outage

The building envelope is an important factor in maintaining livable temperature in spaces during a power outage, but improved design can also allow spaces to be more comfortable during normal operations. With a poor performing envelope, the first few feet of a space adjacent to the exterior wall can be unusable due to thermal comfort issues. Additionally, as interior spaces are better able to maintain their temperature set-points, HVAC run times and system cycling can be reduced, leading to increased HVAC system life times.

Another strategy to improve resilience for residents is to provide an **area of refuge** within the building. The designated space would need to provide minimum levels of heating, cooling, lighting, potable water, and power during power outages for a minimum of 72 hours. This would allow residents to remain in the building during a power outage and to keep warm or cool, store medicine, charge communication devices and share updates. The development team is encouraged to review the *Minimum Backup Power Guidelines for Multi-Unit Residential Buildings*⁵² for additional guidance. Projects are encouraged to consider resilience early in design so that measures can be more easily incorporated.

Key items from checklist: flooding events, extreme heat and cold, power outages, future weather files, back-up generation, batteries, manager and tenant preparedness.

Back-Up Power

With increasing global temperatures, extreme weather events require designs to carefully evaluate back-up power solutions. Typical design intent is to include back-up power via a generator that will supply all emergency (life safety) requirements. Passive design measures such as a relatively low window-wall ratio, high thermal mass elements within the building, and high R-value building insulation would assist in maintaining building temperature in the event of heating/cooling system failure.

⁵²<https://www.toronto.ca/wp-content/uploads/2017/11/91ca-Minimum-Backup-Power-Guideline-for-MURBs-October-2016.pdf>

To increase building resiliency, the project could elect to include back-up power in addition to emergency power on the generator. In general, the difference between these loads is as follows:

Table 22 - Emergency vs. Back-up Power Requirements

	Emergency Power	Back-up Power
Purpose	Minimum life safety requirements (firefighter and evacuation)	Non-life-safety requirements for occupant wellbeing
Duration	2 hours – building code requirement	72 hours – based on federal emergency preparedness guidelines
Loads	Fire pumps, fire elevator, stair pressurization fans, alarm system	Water supply, minimal space heating, power to a common refuge area, domestic booster pumps, additional elevators

Including back-up power on the generator has the potential to increase costs in order to increase the size of the generator, but this can be reduced through the use of a load management system with load selection capability. When the system detects it is no longer in an emergency, it can divert generator resources to back-up power allowing tenants to remain safe and comfortable in their homes during a power outage.

Additional v4 Tier 2, 3, Requirements

Additional TGS v4 energy related credits that this project may consider are listed below:

Mid to High Rise Residential and Non-Residential Development

GHG 2.1 – Material Emissions Assessment (Tier 2)

The building must conduct a Material Emissions Assessment for the structure and envelope in accordance with the CaGBC Zero Carbon Building Standard v2 methodology for the Upfront Carbon lifecycle stage (A1-5). Identify low-carbon sustainable material alternatives to the proposed structure or envelope for use in the building project.

GHG 2.2 Whole Building Life Cycle Assessment (Tier 3)

Conduct a whole building life cycle assessment (LCA) of the building’s structure and envelope in accordance with the CaGBC Zero Carbon Building Standard v2 methodology that demonstrates a minimum of 20% embodied carbon reduction, compared with a baseline building.

GHG 3.2 – Refuge Area and Back-Up Power Generation (Tier 2)

Residential Uses: Provide a refuge area with heating, cooling, lighting, potable water, and power available; AND Provide 72 hours of back-up power to the refuge area and to essential building systems required during an extended power outage.

GHG 4.1 – Benchmarking & Reporting (Tier 2)

Enroll the project in ENERGYSTAR® Portfolio Manager to track energy and water consumption of the new development during operations in accordance with O. Reg. 20/17 for private buildings. Provide the City of Toronto's account (CotEnergy) with read-only access to the project.

GHG 4.2 – Enhanced Commissioning (Tier 2)

Complete the commissioning process (CxP) activities for mechanical, electrical, plumbing, and renewable energy systems and assemblies in accordance with ASHRAE Guideline 0–2013 and ASHRAE Guideline 1.1–2007 for HVAC&R systems, as they relate to energy, water, indoor environmental quality, and durability, to develop the owner's project requirements and basis of design.

GHG 4.3 – Whole Building Air Leakage Testing WBALT (Tier 2)

Conduct a Whole-building Air Leakage Test to improve the quality and air tightness of the building envelope. The project must target equal to or less than 2 L/s/m² (at 75 Pa) through whole-building air infiltration testing, as conducted in accordance with the City of Toronto Air Tightness Testing Protocol & Process Guideline.